

# Pamapic 10\*12FT Gazebo

*Thank you very much  
for purchasing our product.*

## INSTRUCTION MANUAL

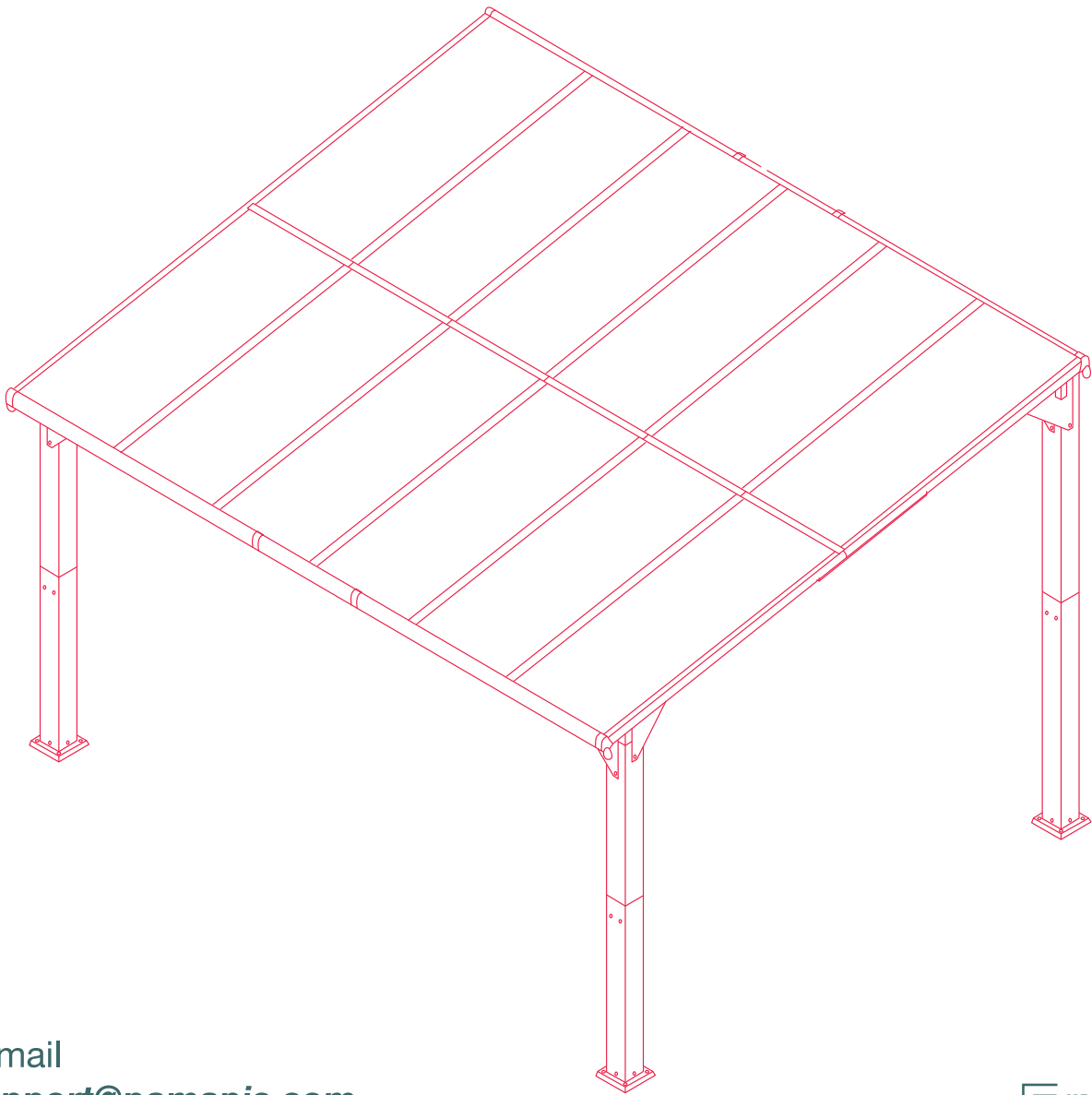

- E-mail  
[support@pamapic.com](mailto:support@pamapic.com)
- Facebook  
[@pamapic.official](https://www.facebook.com/pamapic.official)

▶  
Instruction  
Video



# Instruction Video



---

If you have any question please  
contact customer service:

**E-mail:** [support@pamapic.com](mailto:support@pamapic.com)  
**Facebook:** [@pamapic.official](https://www.facebook.com/pamapic.official)

Instruction  
Video



## CAUTION

● **Parts and Parts List:** Before you start, separate and identify all the parts and hardware to be sure that you have all the necessary parts for your building (refer to the Parts List Page).

If you find that a part is missing, please notify the seller within one week after receiving the product. Do not attempt to assemble the building if parts are missing because any building left partially assembled may be seriously damaged by light winds.

● **Tools you need:** Please tear off the safety protection layer before the assembly, keep the part number label if needed.

## ASSEMBLY PREPARATION

### Warning

● **Owner's Manual:** Please check local building codes regarding footings, location and other requirements before beginning construction.

● **Assembly instructions:** Reviewing all instructions and the appropriate information before you begin, make sure following the step sequence carefully for successful results.

## ATTENTION

### Warning

● Select a dry and calm day for your assembly. Team works (Two or more people) are required during the assembly. It is also recommended to finish the assembly in a day to avoid damage to the product or missing of some small parts.

● Wearing safety gloves, eye protection and long sleeves during the assembly to prevent injury. Pay attention to the sharp edge of some parts.

● Children and pets are not allowed entering into the construction site.

● Never concentrate your total weight on the roof of the building. When using a step ladder make sure that it is safe.

## CARE & MAINTENANCE

● Keep the shed clean with soft cloth, use water if necessary.

● Clean the snow with necessary tools to make sure it is safe to enter into.

● The shed is not made for living but storing stuff.

If you have any question please  
contact customer service:

**E-mail:** [support@pamapic.com](mailto:support@pamapic.com)

**Facebook:** [@pamapic.official](https://www.facebook.com/pamapic.official)

Instruction  
Video



# PARTS

Prepare the required parts as shown in the diagram and get ready to start the installation.

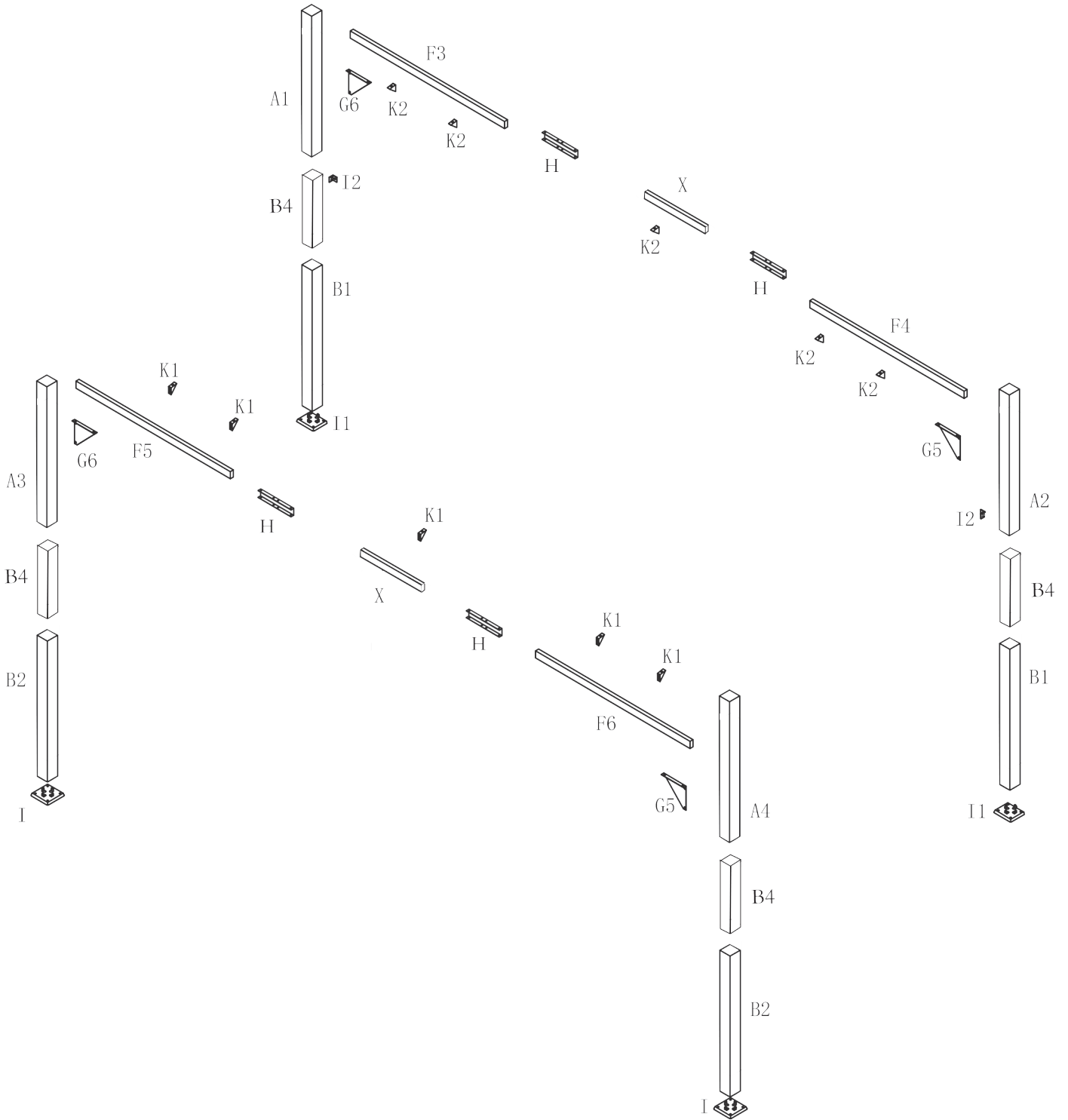

If you have any question please contact customer service:

**E-mail:** [support@pamapic.com](mailto:support@pamapic.com)  
**Facebook:** [@pamapic.official](https://www.facebook.com/pamapic.official)

Instruction Video



# PARTS

Prepare the required parts as shown in the diagram and get ready to start the installation.

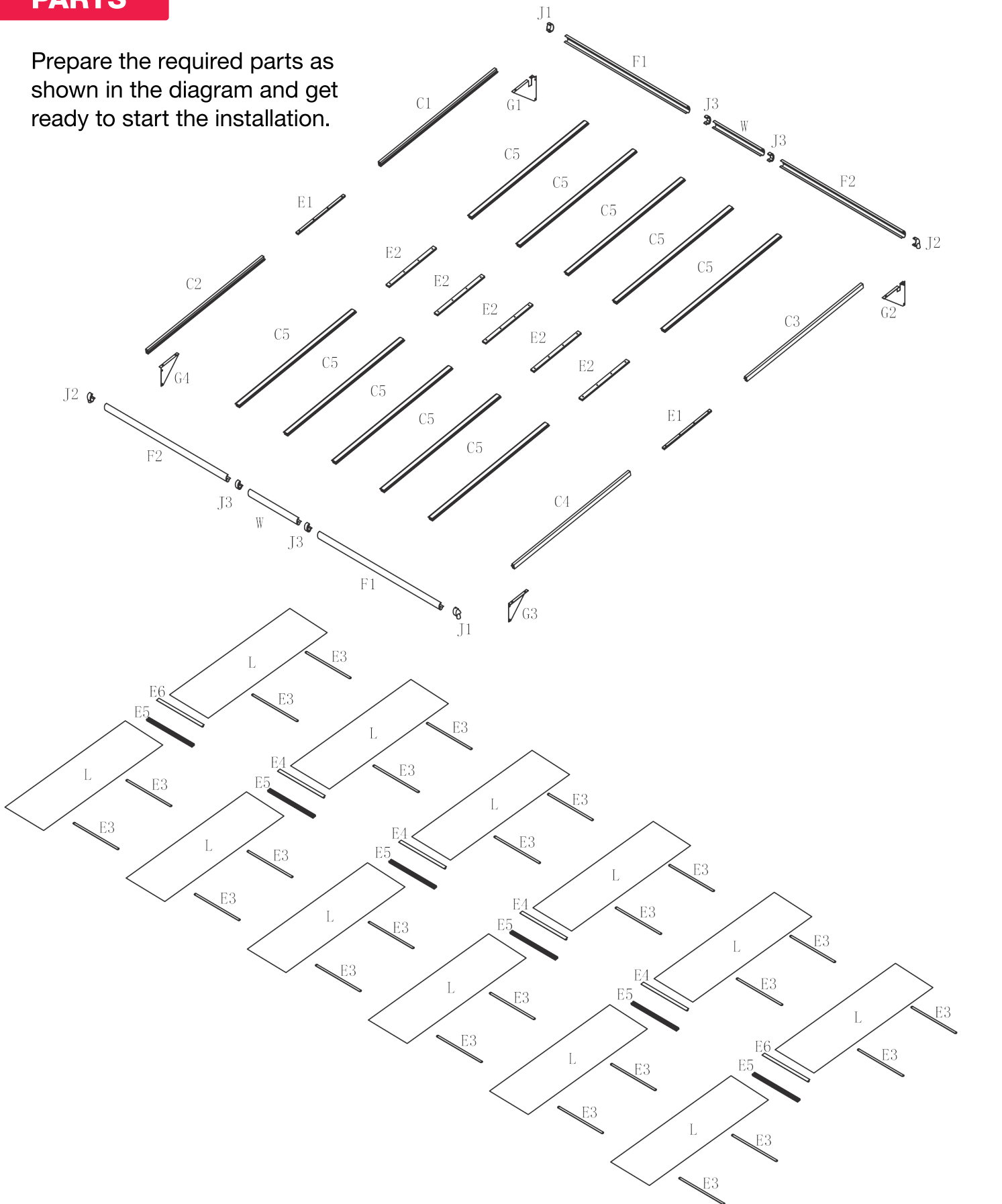











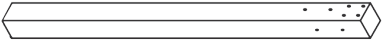

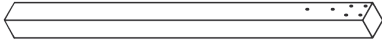

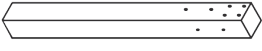

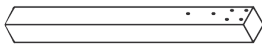

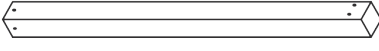

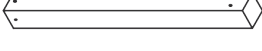









Instruction Video

If you have any question please contact customer service:

**E-mail:** [support@pamapic.com](mailto:support@pamapic.com)  
**Facebook:** [@pamapic.official](https://www.facebook.com/pamapic.official)

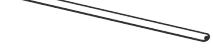

# PARTS

IMAGE (Pieza)	NO. (Número)	QTY (Cantidad)	Box No. (Número de Caja)
 	A1	1	1/2
 	A2	1	1/2
 	A3	1	1/2
 	A4	1	1/2
 	B1	2	1/2
 	B2	2	1/2
 	C1	1	2/2
 	C2	1	2/2
 	C3	1	2/2
 	C4	1	2/2
 	C5	10	2/2
 	E1	2	1/2
 	E2	5	1/2
 	E3	24	1/2
 	E4	4	1/2





















Instruction Video



If you have any question please contact customer service:

**E-mail:** [support@pamapic.com](mailto:support@pamapic.com)  
**Facebook:** [@pamapic.official](https://www.facebook.com/pamapic.official)

# PARTS

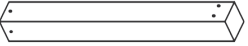
		E5	6	1/2
		E6	2	1/2
		F1	2	2/2
		F2	2	2/2
		F3/F4	1/1	2/2
		F5/F6	1/1	2/2
		G1	1	1/2
		G2	1	1/2
		G3	1	1/2
		G4	1	1/2
		G5	2	1/2
		G6	2	1/2
		I	2	1/2
		I1	2	1/2
		I2	2	1/2
		B3	1	1/2
		B4	4	1/2















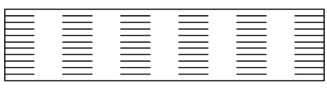
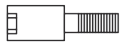

If you have any question please contact customer service:

**E-mail:** [support@pamapic.com](mailto:support@pamapic.com)  
**Facebook:** [@pamapic.official](https://www.facebook.com/pamapic.official)

Instruction Video



# PARTS

	J1	2	1/2
	J2	2	1/2
	J3	4	1/2
	K1	5	1/2
	K2	5	1/2
	L	12	2/2
	M	16	1/2
 M5x6	O	48	1/2
 M5x15	P	64	1/2
 M5x28	Q	28	1/2
 M6x15	S	100	1/2
 M6x68	T	16	1/2
 	U/U(2)	18	1/2
 M5x20	V	18	1/2
 	W	2	1/2
 	X	2	2/2
	H	4	1/2

If you have any question please contact customer service:

**E-mail:** [support@pamapic.com](mailto:support@pamapic.com)  
**Facebook:** [@pamapic.official](https://www.facebook.com/pamapic.official)

Instruction Video







# INSTRUCTIONS

Scan the QR code in the footer section and scroll to the bottom of the web page to find the installation video for this product.

## Step 1

 **Check the package contents before getting started !**  
(¡Revise el contenido del paquete antes de comenzar!)

F3/F5		X1/X1	F4/F6		X1/X1
X		X2	T		X16
H		X4			

Knock the H accessories into F3 and F4. Note that you should align the holes first before knocking them in, and make sure the side with holes faces the same direction. Please refer to the diagram.

Similarly, knock the H accessories into F5 and F6, with the same note: align the holes first before knocking them in.

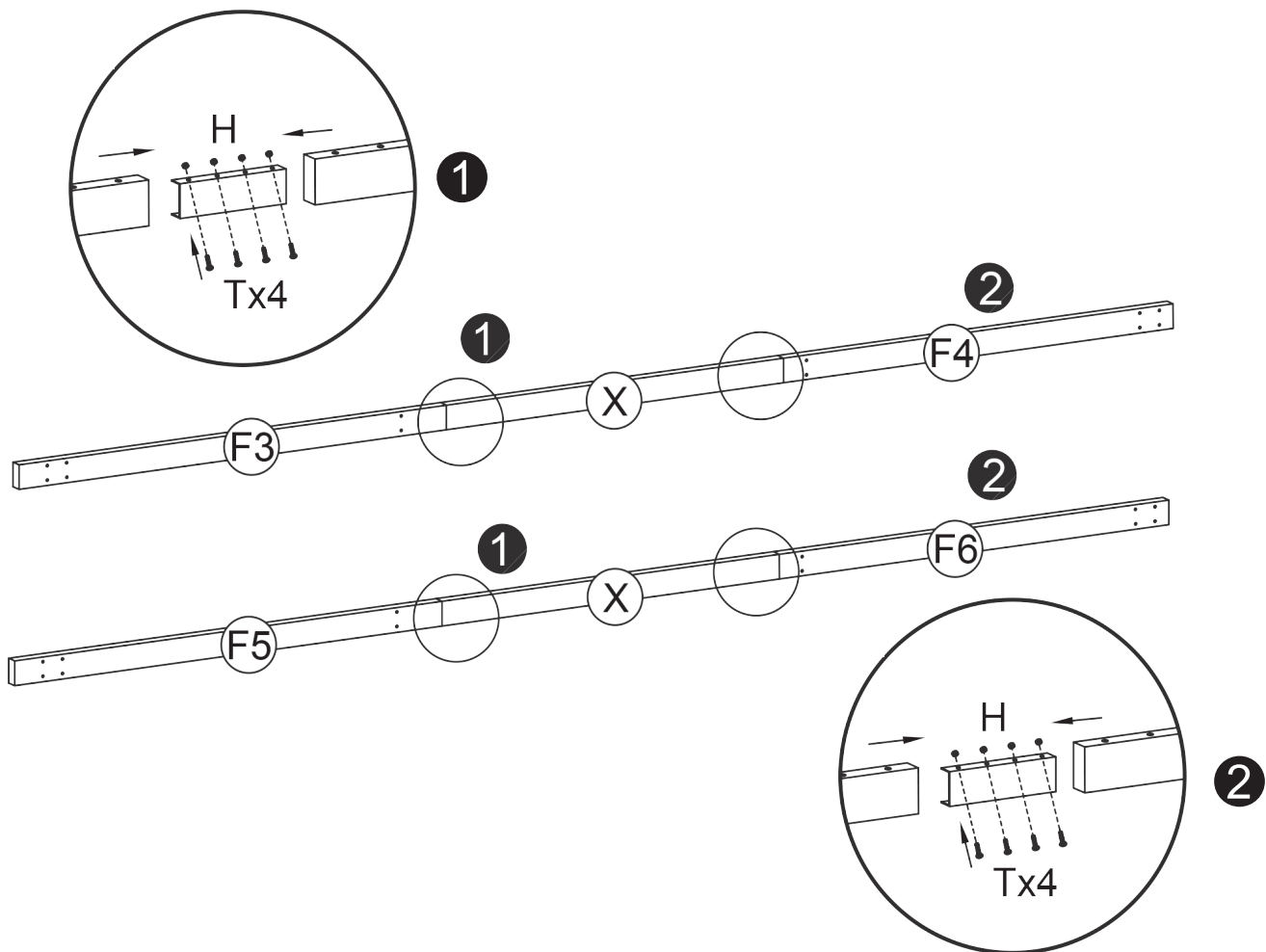

If you have any question please contact customer service:

**E-mail:** [support@pamapic.com](mailto:support@pamapic.com)  
**Facebook:** [@pamapic.official](https://www.facebook.com/pamapic.official)

Instruction Video



# INSTRUCTIONS

## Step 2

A1		X1	A2		X1
A3		X1	A4		X1
B1		X2	B2		X2
I		X2	I1		X2
S		X64	B4		X4

Pay attention to the letter stickers and pair them according to the diagram.  
When installing I1, be careful with the direction, as shown in the diagram.

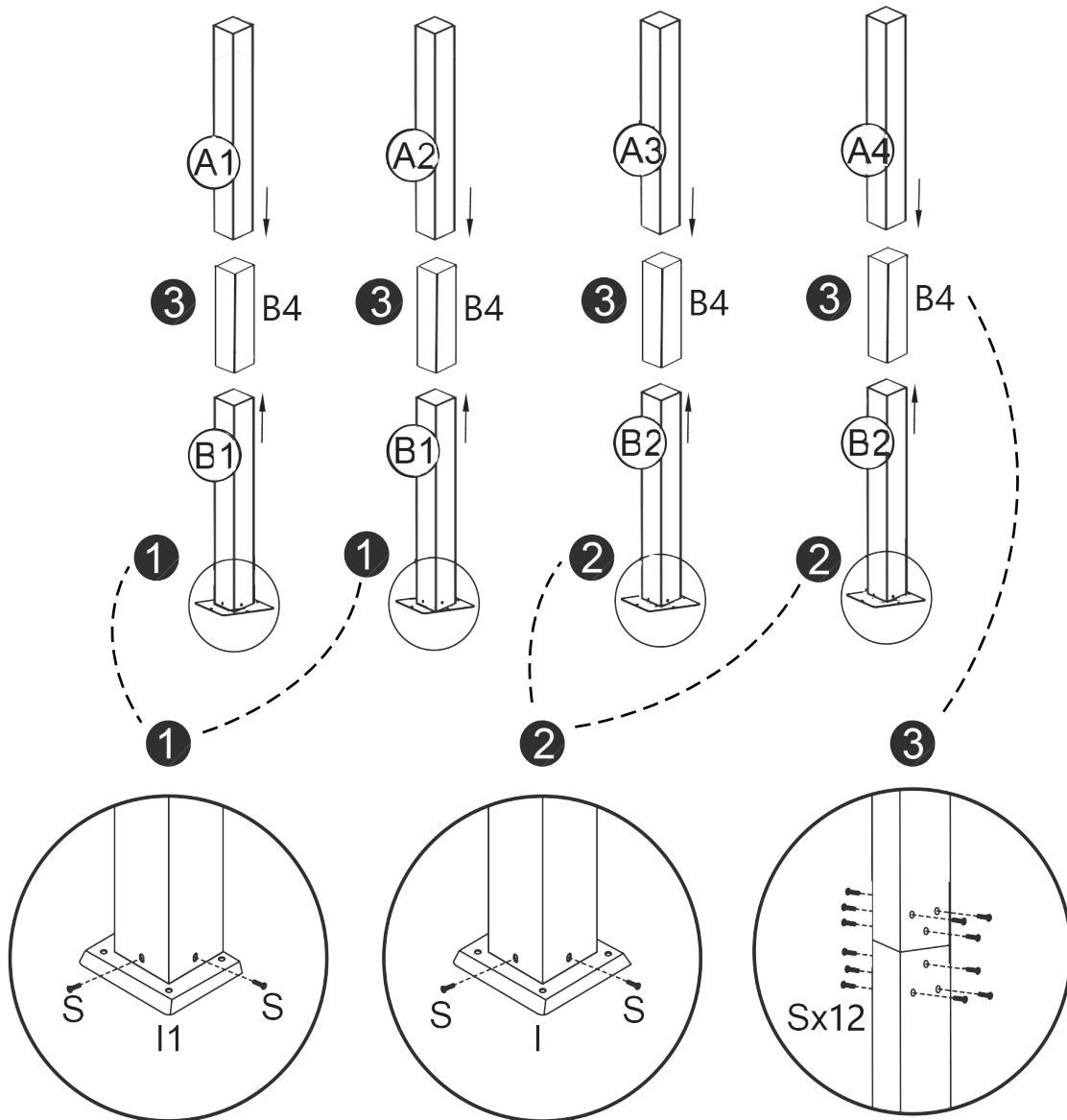

Instruction  
Video



If you have any question please  
contact customer service:

**E-mail:** [support@pamapic.com](mailto:support@pamapic.com)  
**Facebook:** [@pamapic.official](https://www.facebook.com/pamapic.official)

# PARTS

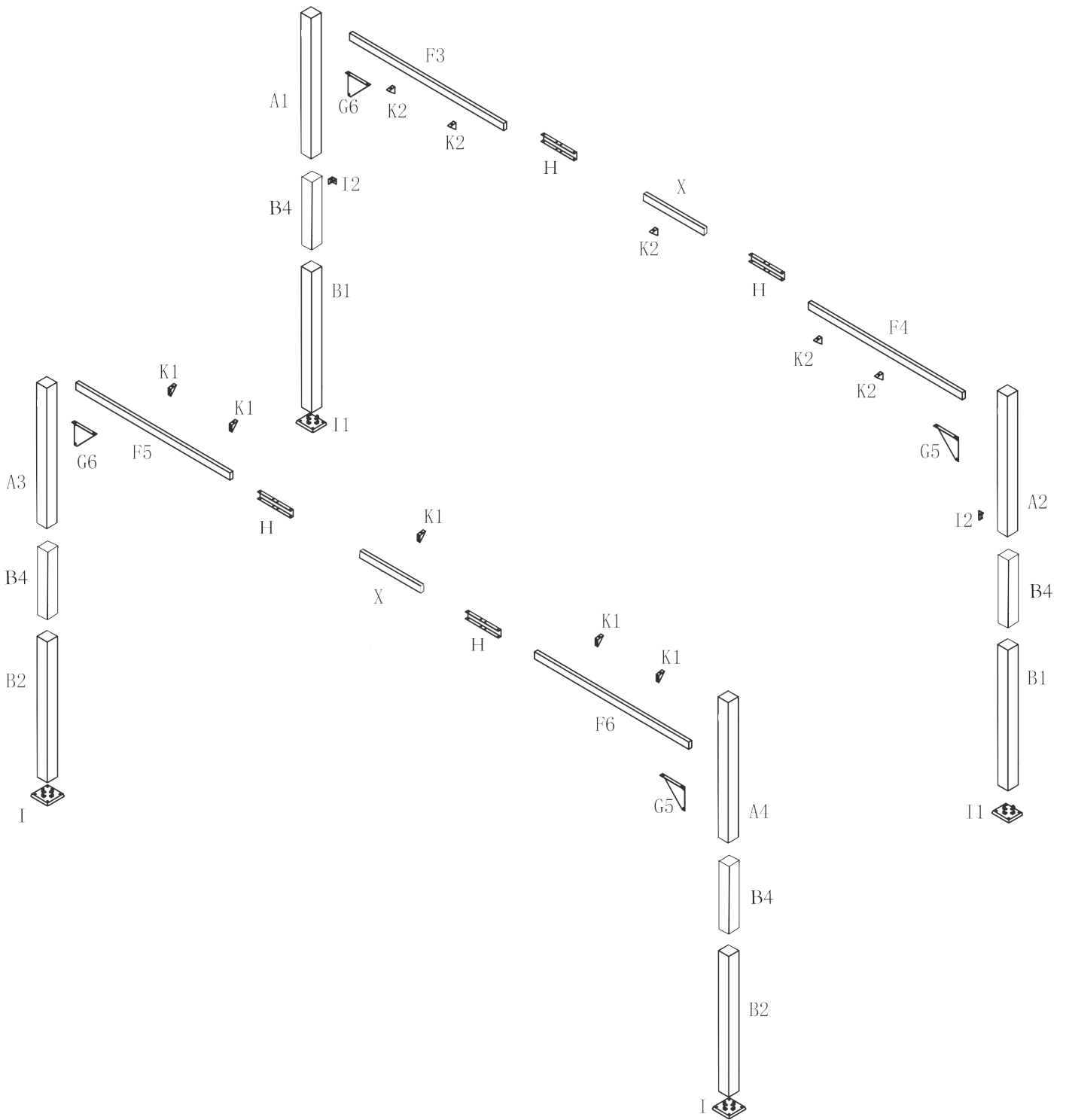

If you have any question please contact customer service:

**E-mail:** [support@pamapic.com](mailto:support@pamapic.com)  
**Facebook:** [@pamapic.official](https://www.facebook.com/pamapic.official)

Instruction Video



# INSTRUCTIONS

## Step 3

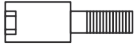
M		X16
---	---	-----

Install F3 and F4 on the A1 and A2 columns. Note that F3 should be connected to the A1 side, and F4 to the A2 side.

Install F5 and F6 on the A3 and A4 columns. Ensure that F5 is connected to the A3 side, and F6 to the A4 side.

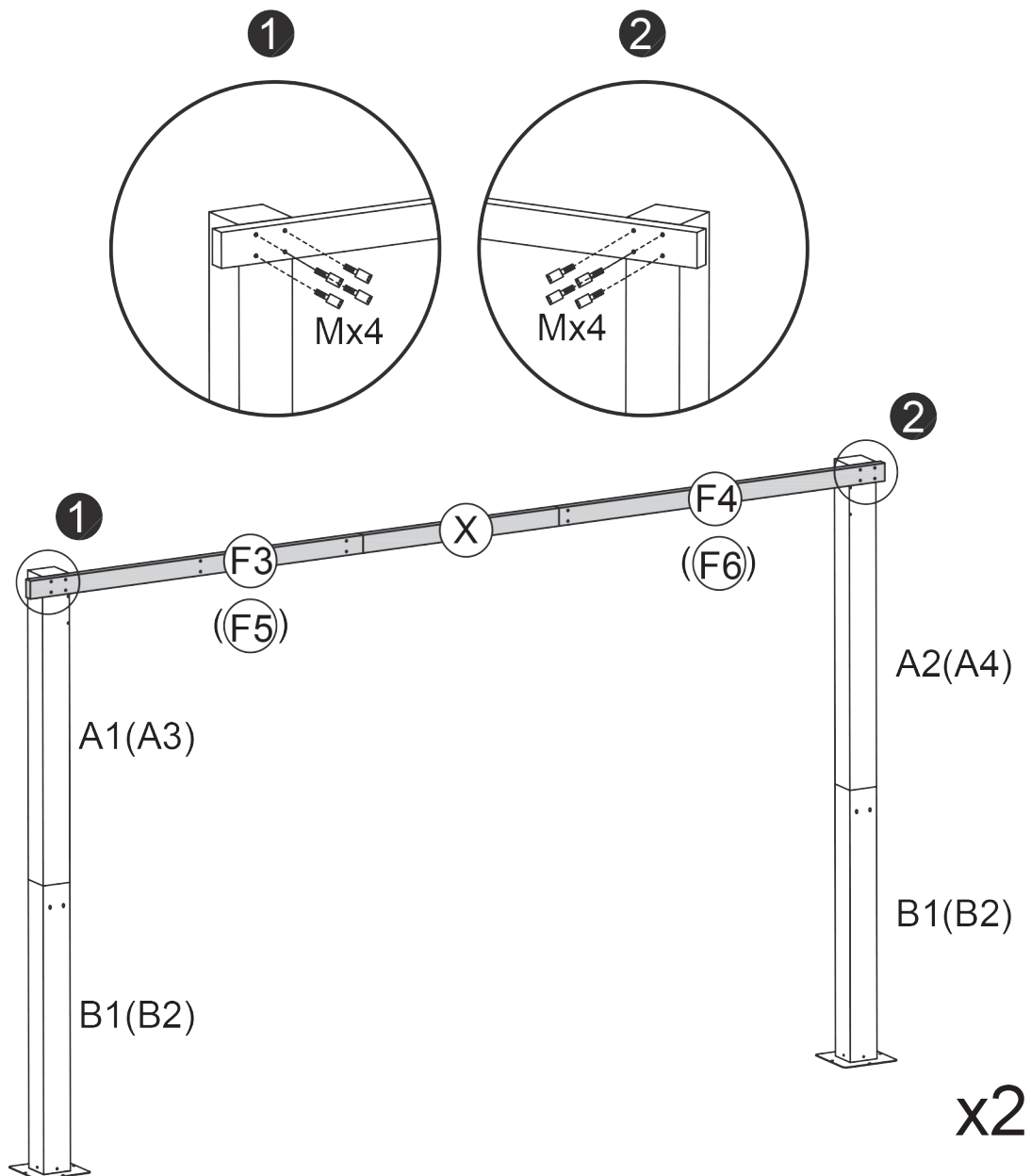

If you have any question please contact customer service:



**E-mail:** [support@pamapic.com](mailto:support@pamapic.com)  
**Facebook:** [@pamapic.official](https://www.facebook.com/pamapic.official)

Instruction Video



# INSTRUCTIONS

## Step 4

G5		X2	G6		X2
S		X16			

Install the triangular brackets, paying attention to the letter codes—mount them on the corresponding corners.

When tightening the screws, you can first screw them all in halfway; once all the holes are aligned, then fully tighten them. As shown in the diagram.

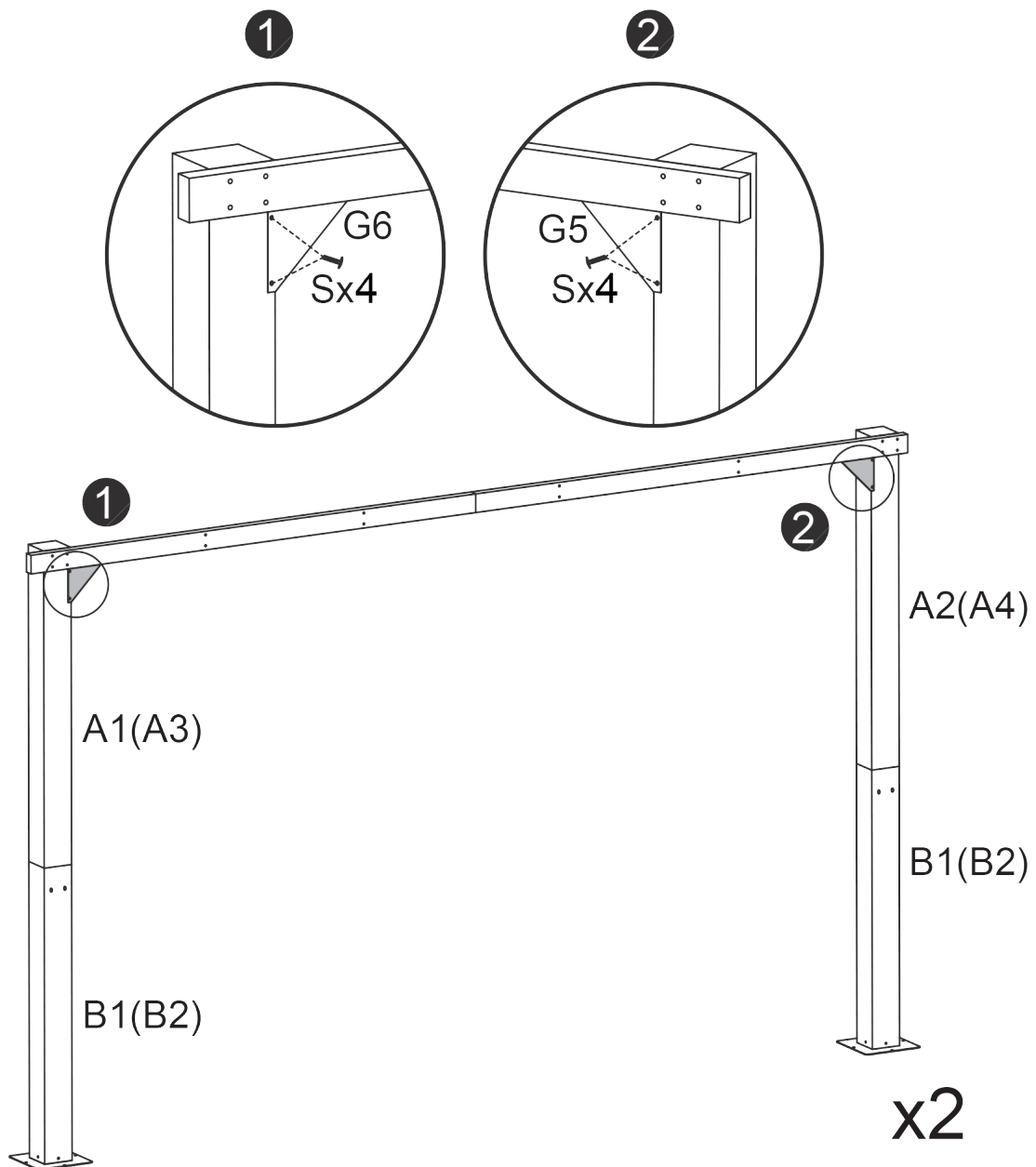

If you have any question please contact customer service:









**E-mail:** [support@pamapic.com](mailto:support@pamapic.com)  
**Facebook:** [@pamapic.official](https://www.facebook.com/pamapic.official)

Instruction Video



# INSTRUCTIONS

## Step 5

C1		X1	C2		X1
C3		X1	C4		X1
C5		X10	E1		X2
E2		X5	Q		X28

1-Install the two E1 pieces: one on C1 and C2, and the other on C3 and C4. Pay attention to the hole positions and the direction of the C beams. Remember to align the clamping grooves for the sunboard.

2-Connect E2 to C5. Note the direction of the C beam and ensure the sunboard clamping grooves are properly aligned.

As shown in the diagram.

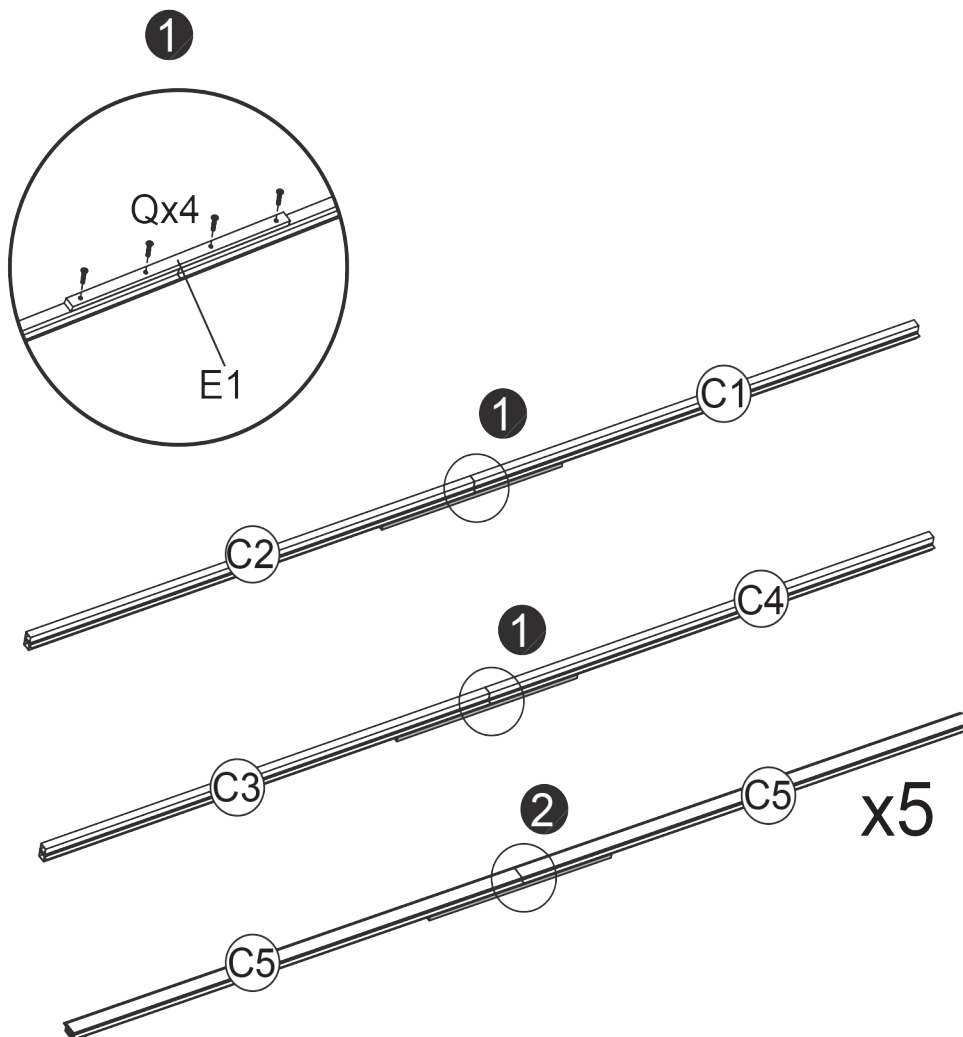

If you have any question please contact customer service:









**E-mail:** [support@pamapic.com](mailto:support@pamapic.com)  
**Facebook:** [@pamapic.official](https://www.facebook.com/pamapic.official)

Instruction Video



# INSTRUCTIONS

## Step 5

C1		X1	C2		X1
C3		X1	C4		X1
C5		X10	E1		X2
E2		X5	Q		X28

1-Install the two E1 pieces: one on C1 and C2, and the other on C3 and C4. Pay attention to the hole positions and the direction of the C beams. Remember to align the clamping grooves for the sunboard.

2-Connect E2 to C5. Note the direction of the C beam and ensure the sunboard clamping grooves are properly aligned.

As shown in the diagram.

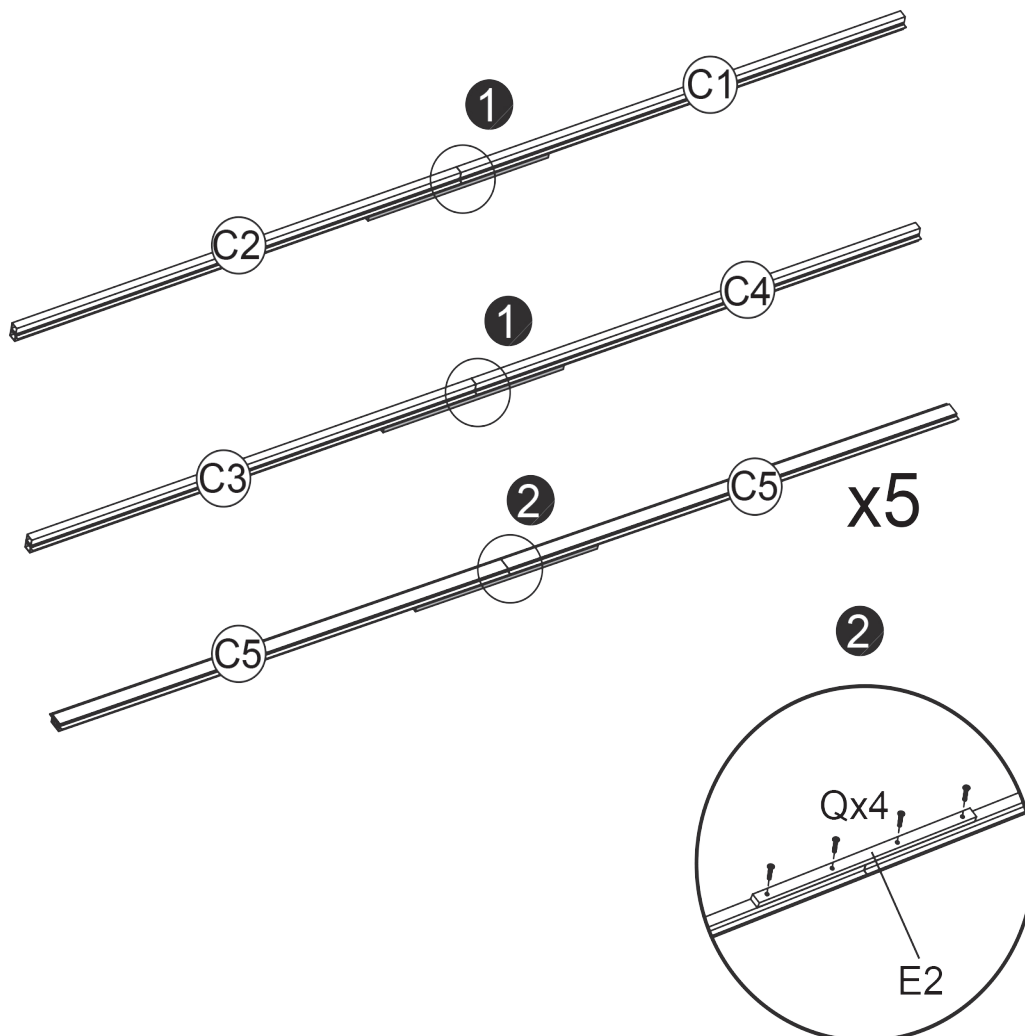

Instruction  
Video



If you have any question please  
contact customer service:

**E-mail:** [support@pamapic.com](mailto:support@pamapic.com)

**Facebook:** [@pamapic.official](https://www.facebook.com/pamapic.official)

# INSTRUCTIONS

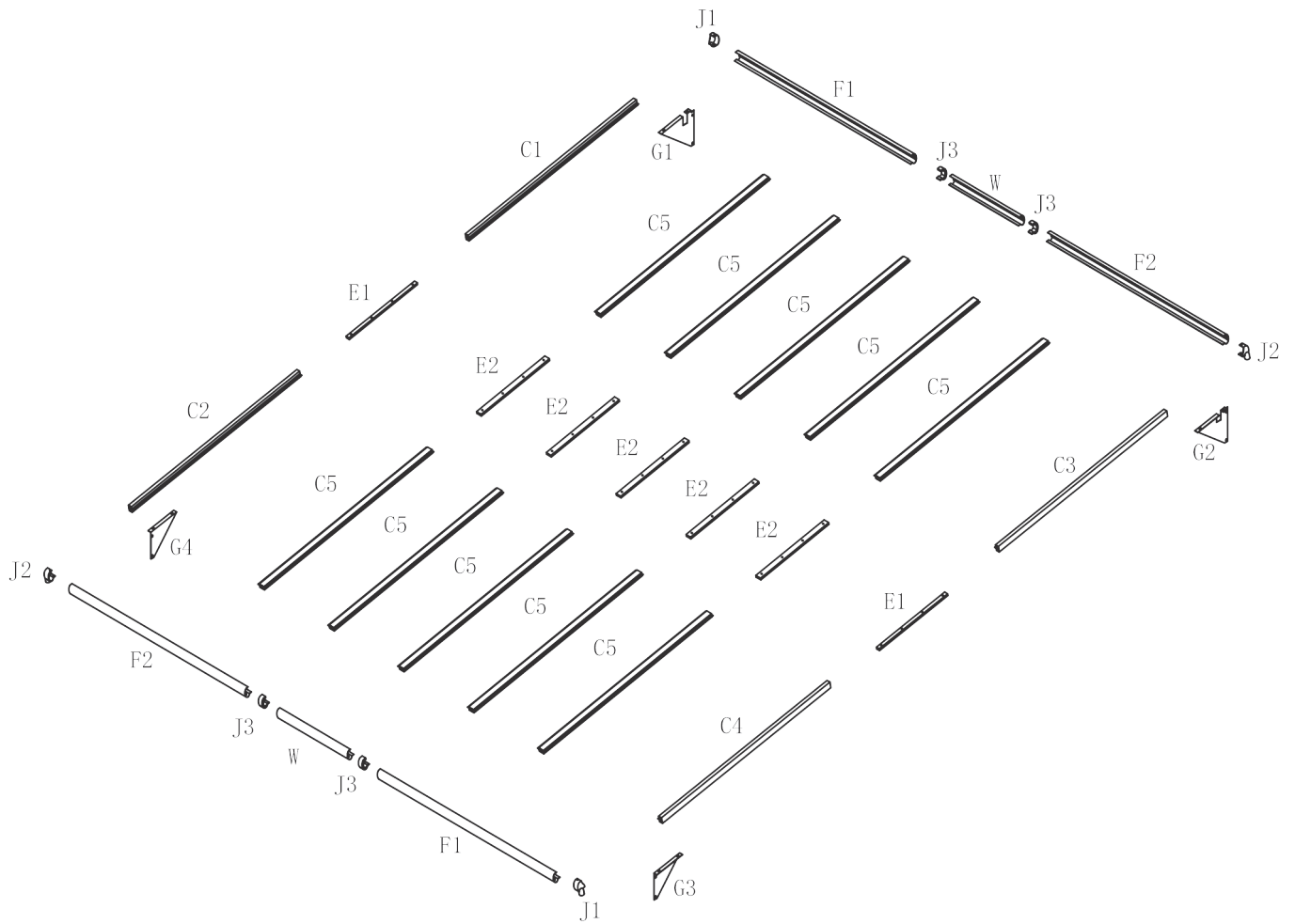

If you have any question please  
contact customer service:





**E-mail:** [support@pamapic.com](mailto:support@pamapic.com)  
**Facebook:** [@pamapic.official](https://www.facebook.com/pamapic.official)

Instruction  
Video



# INSTRUCTIONS

## Step 6

G1		X1	G2		X1
G3		X1	G4		X1
S		X16			

Pay attention to the direction and the positions of each column. Refer to pages 2 and 3: connect C1 to column A1, C2 to column A3, C3 to column A2, and C4 to column A4.

When installing the triangular plates, first screw the screws in halfway. Wait until all holes are aligned and all screws are in place, then fully tighten them.

The grooved sides of the two beams C1-C2 and C3-C4 should face inward. Pay attention to the left and right positions during installation.

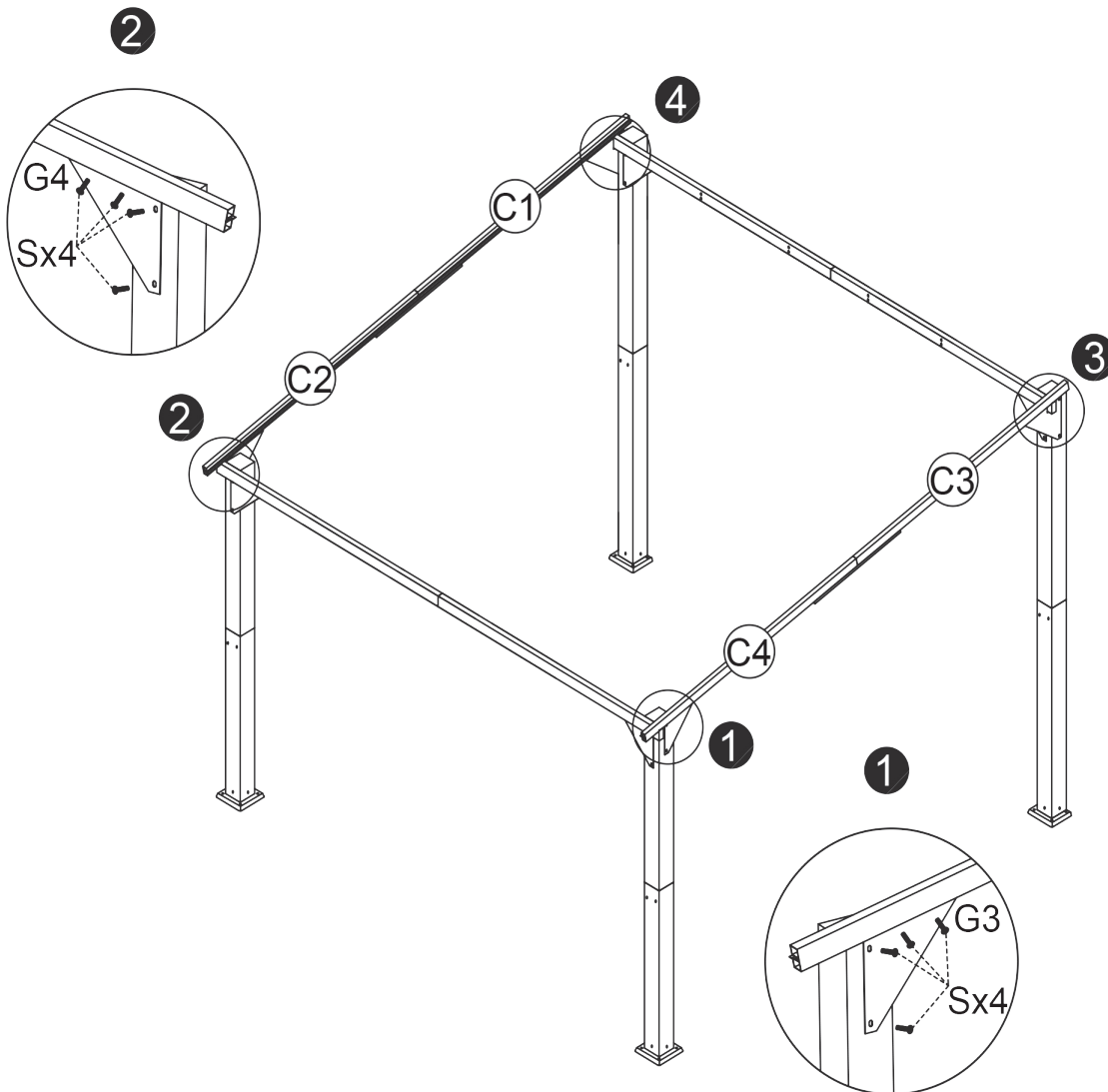

Instruction  
Video







If you have any question please  
contact customer service:

**E-mail:** [support@pamapic.com](mailto:support@pamapic.com)  
**Facebook:** [@pamapic.official](https://www.facebook.com/pamapic.official)

# INSTRUCTIONS

## Step 6

G1		X1	G2		X1
G3		X1	G4		X1
S		X16			

Pay attention to the direction and the positions of each column. Refer to pages 2 and 3: connect C1 to column A1, C2 to column A3, C3 to column A2, and C4 to column A4.

When installing the triangular plates, first screw the screws in halfway. Wait until all holes are aligned and all screws are in place, then fully tighten them.

The grooved sides of the two beams C1-C2 and C3-C4 should face inward. Pay attention to the left and right positions during installation.

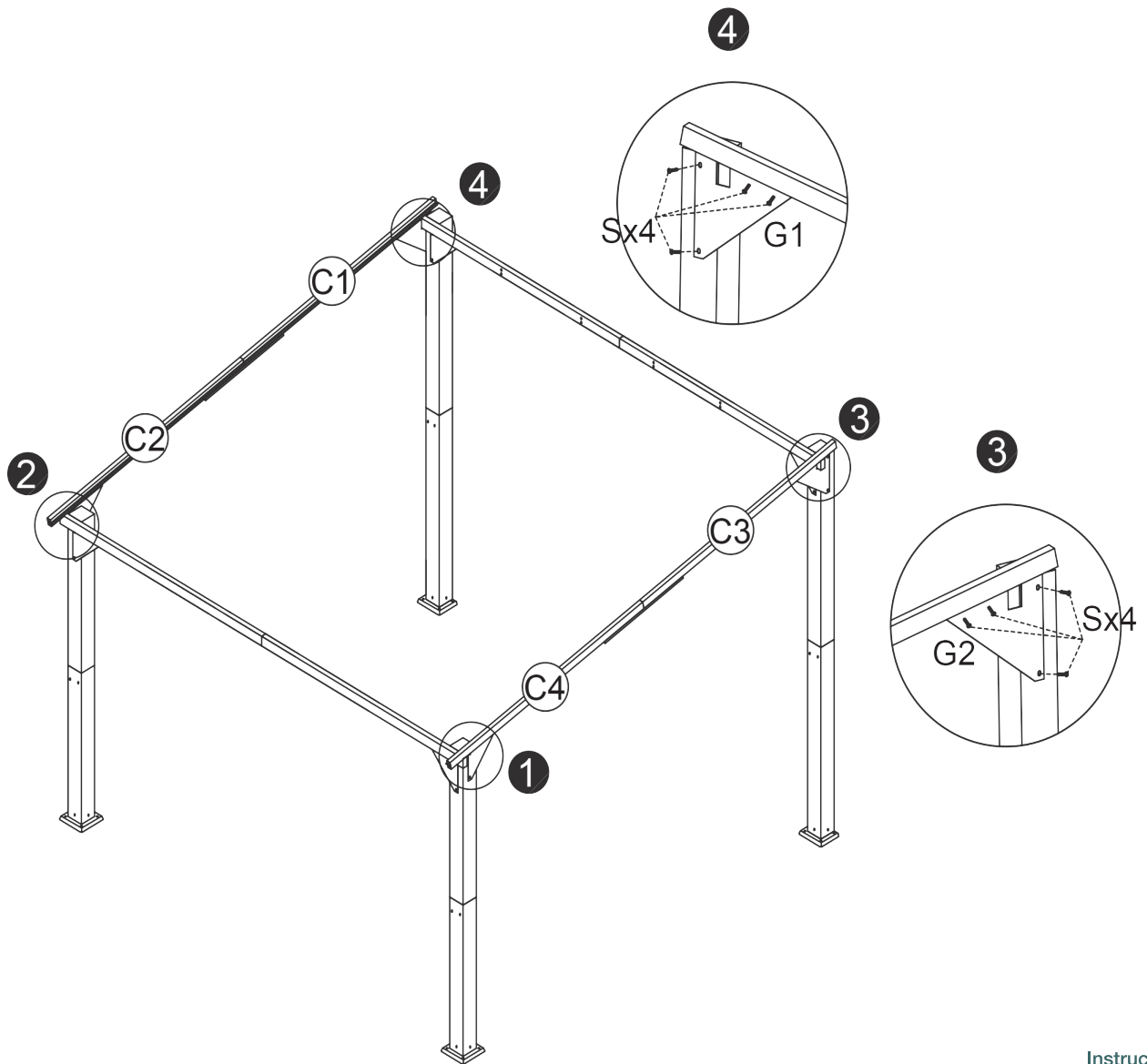

Instruction Video





If you have any question please contact customer service:

**E-mail:** [support@pamapic.com](mailto:support@pamapic.com)

**Facebook:** [@pamapic.official](https://www.facebook.com/pamapic.official)

# INSTRUCTIONS

## Step 7

K1		X5	K2		X5
P		X20			

Install K1 on F5 and F6. Note that the side with a single hole should face upward, and the side with two holes should be fixed to the crossbeam.

Install K2 on F3 and F4. Ensure the single-hole side faces upward, and the two-hole side is secured to the crossbeam.

As shown in the diagram.

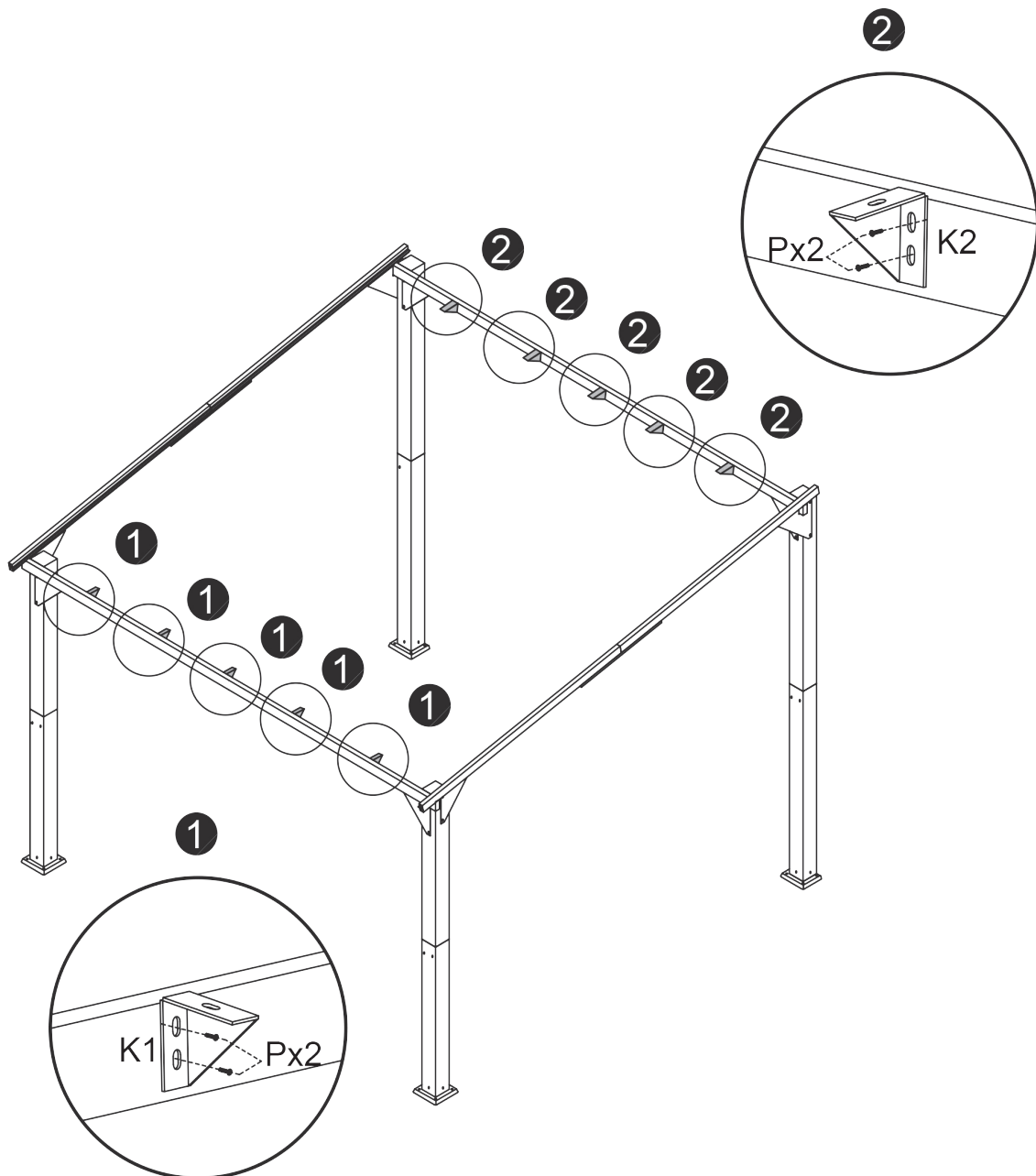

If you have any question please contact customer service:

**E-mail:** [support@pamapic.com](mailto:support@pamapic.com)  
**Facebook:** [@pamapic.official](https://www.facebook.com/pamapic.official)

Instruction Video



# INSTRUCTIONS

## Step 8

P		X10
---	---	-----

Refer to Step 5: Connect the C5 pieces in pairs first, then install the 5 connected pillars onto the ceiling.

Pay attention to the direction—ensure E2 faces downward, as shown in the diagram.

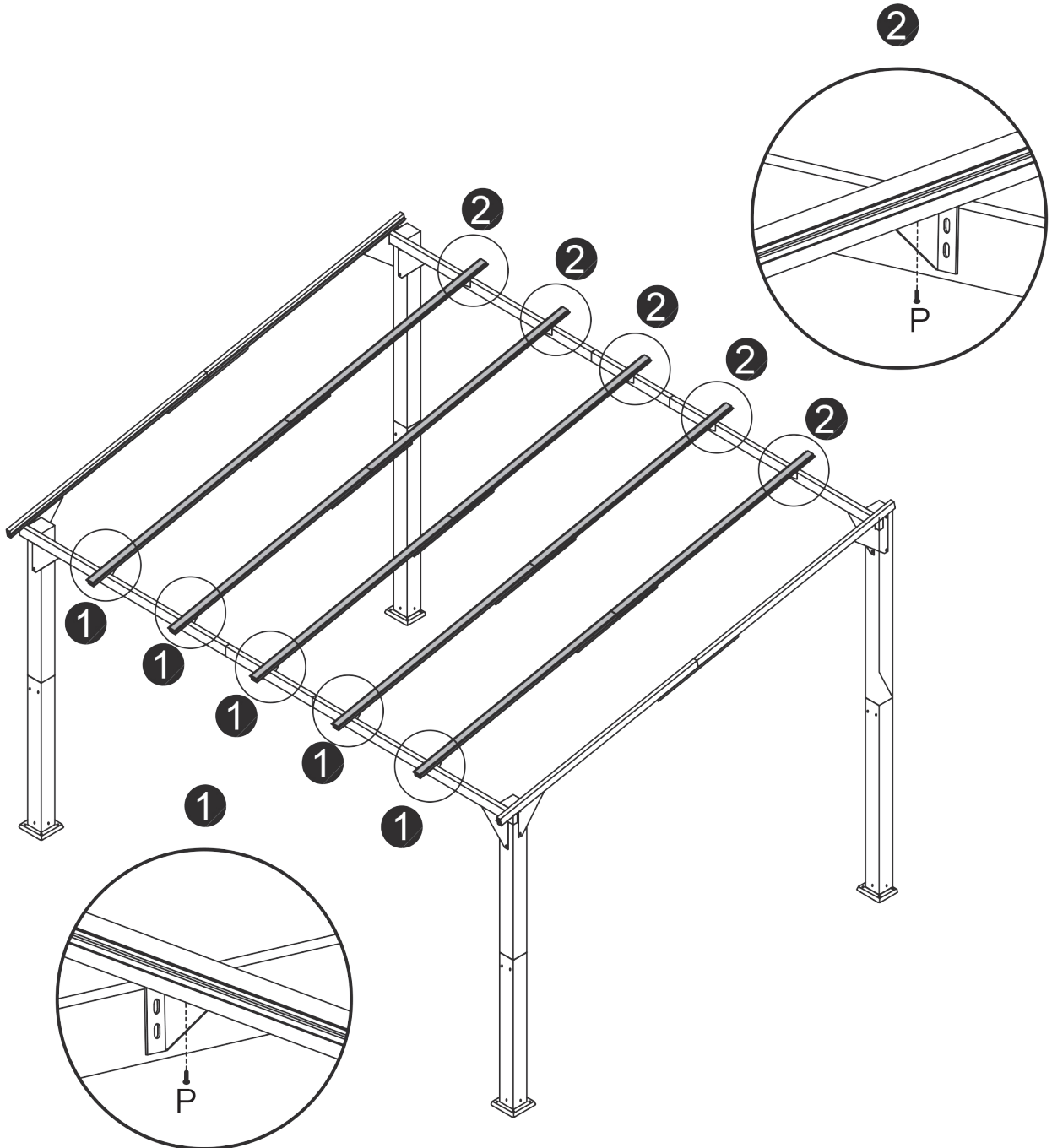

Instruction  
Video

If you have any question please  
contact customer service:

**E-mail:** [support@pamapic.com](mailto:support@pamapic.com)  
**Facebook:** [@pamapic.official](https://www.facebook.com/pamapic.official)



# INSTRUCTIONS

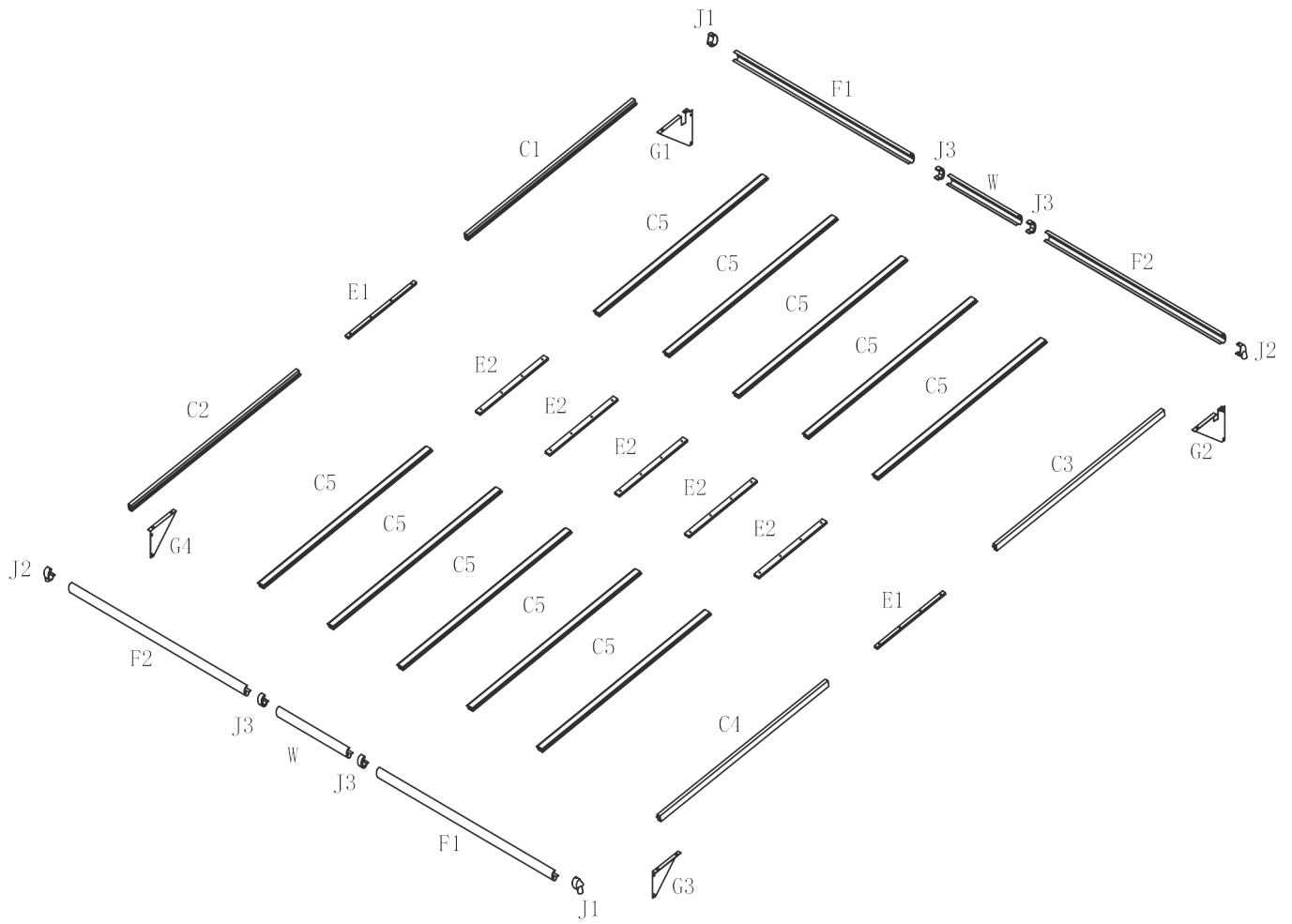

If you have any question please contact customer service:





**E-mail:** [support@pamapic.com](mailto:support@pamapic.com)  
**Facebook:** [@pamapic.official](https://www.facebook.com/pamapic.official)

Instruction Video



# INSTRUCTIONS

## Step 9

E5		X1	E6		X1
L		X2	V		X3

1-Do not fully tighten the E5 and E6 screws; leave a gap of approximately 7mm. Note the direction of E6: the extended end should face inward.

2-Slide both L pieces into the Slot and fasten them onto E5 and E6. Only after they are securely in place should you fully tighten the E5 and E6 screws.

As shown in the diagram.

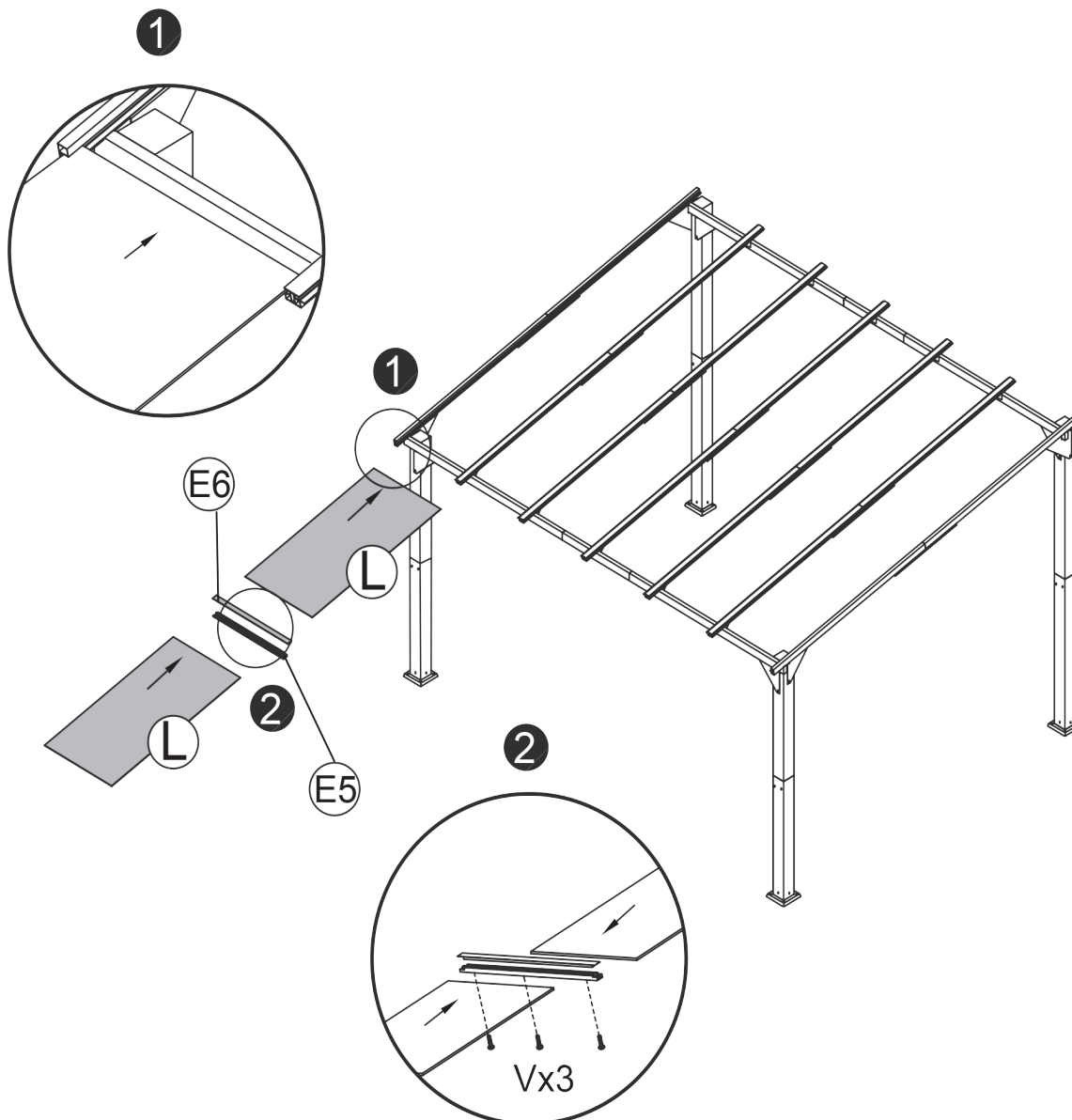

If you have any question please contact customer service:

**E-mail:** [support@pamapic.com](mailto:support@pamapic.com)  
**Facebook:** [@pamapic.official](https://www.facebook.com/pamapic.official)

Instruction Video



# INSTRUCTIONS

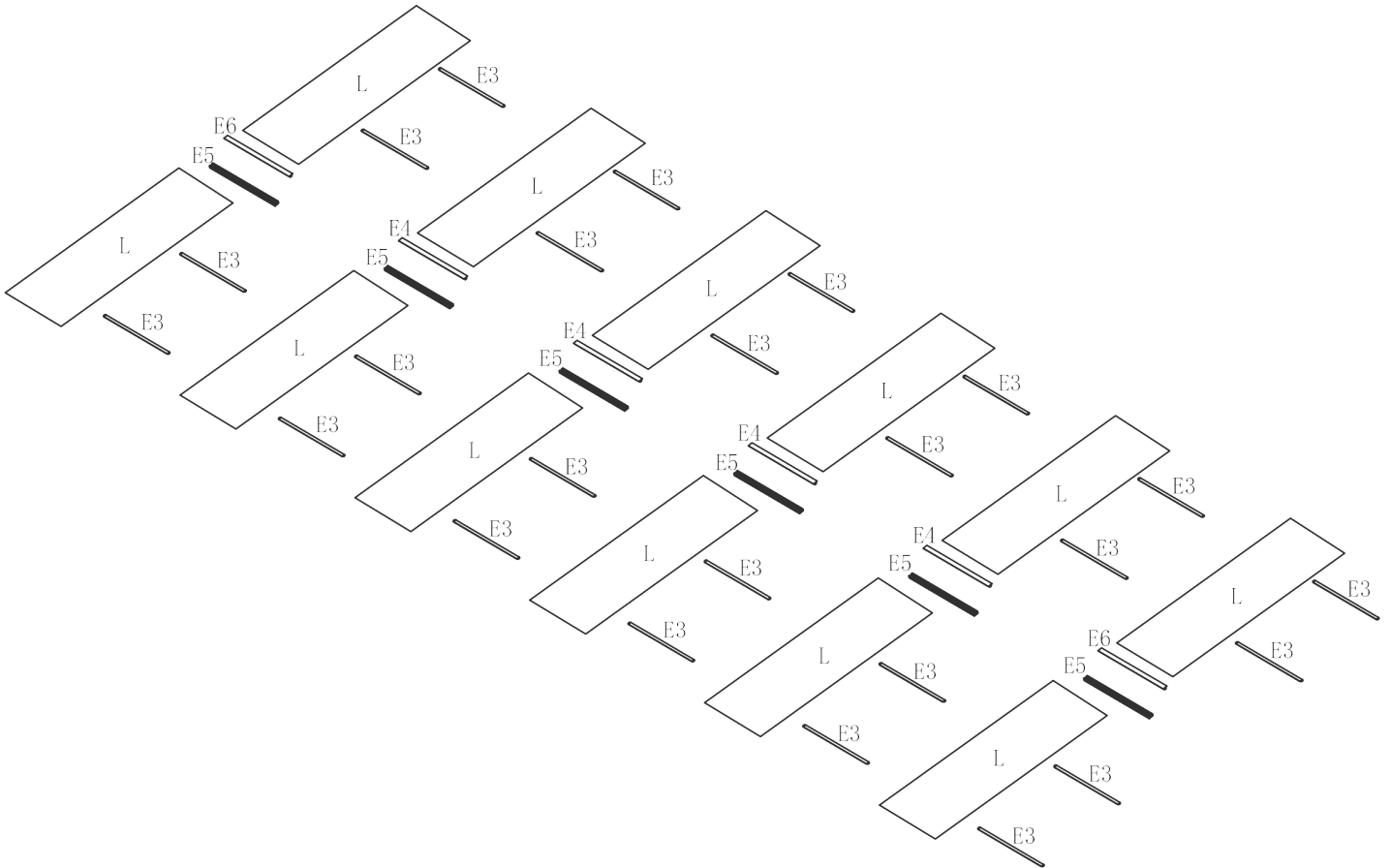

If you have any question please  
contact customer service:









**E-mail:** [support@pamapic.com](mailto:support@pamapic.com)  
**Facebook:** [@pamapic.official](https://www.facebook.com/pamapic.official)

Instruction  
Video



# INSTRUCTIONS

## Step 10

E4			X4	E5			X5
E6			X1	L			X10
V			X15				

1-Do not fully tighten the E5 and E4 screws; leave a gap of approximately 7mm. Note the direction of E4: the extended end should face inward.

2-Slide both L pieces into the Slot and fasten them onto E5 and E4. Only after they are securely in place should you fully tighten the E5 and E4 screws.

As shown in the diagram.

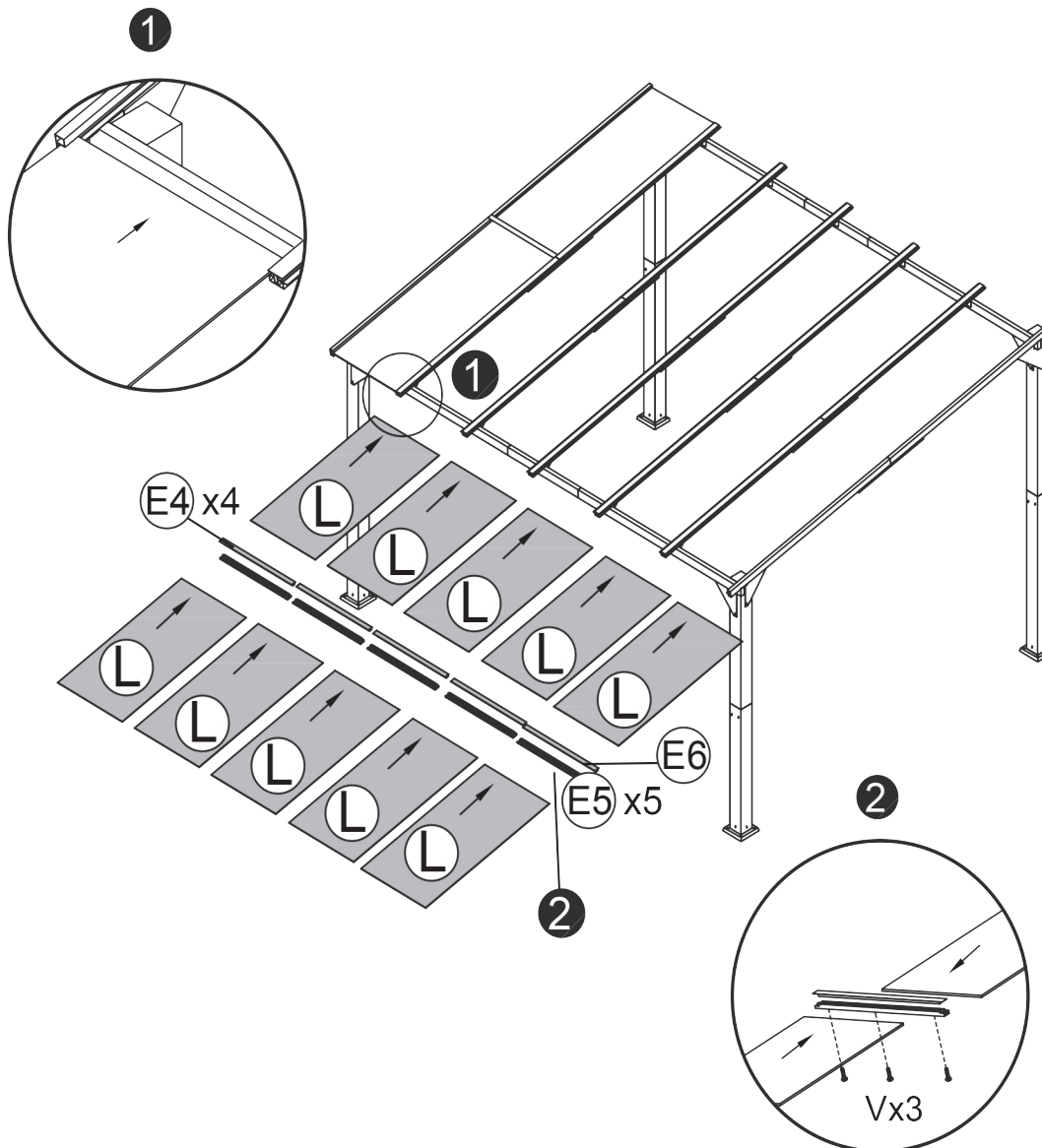

Instruction  
Video



If you have any question please  
contact customer service:

**E-mail:** [support@pamapic.com](mailto:support@pamapic.com)  
**Facebook:** [@pamapic.official](https://www.facebook.com/pamapic.official)

# INSTRUCTIONS

## Step 11

E3		X24	O		X48
----	---	-----	---	---	-----

Place E3 under the sunboard L, align the holes, and then tighten the screws.

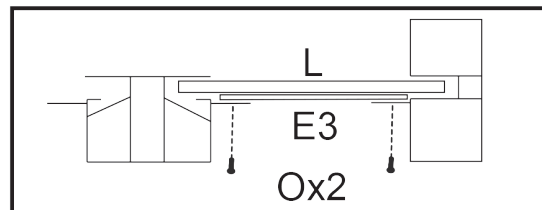
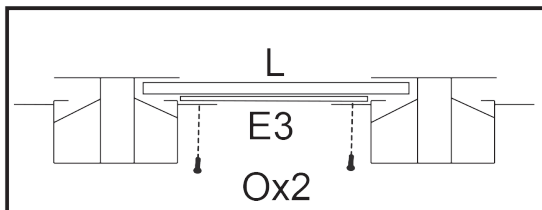
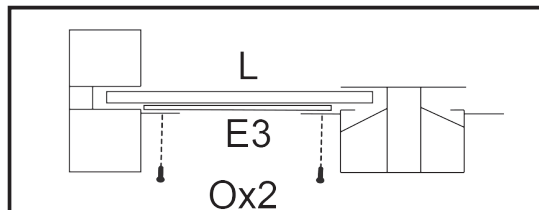
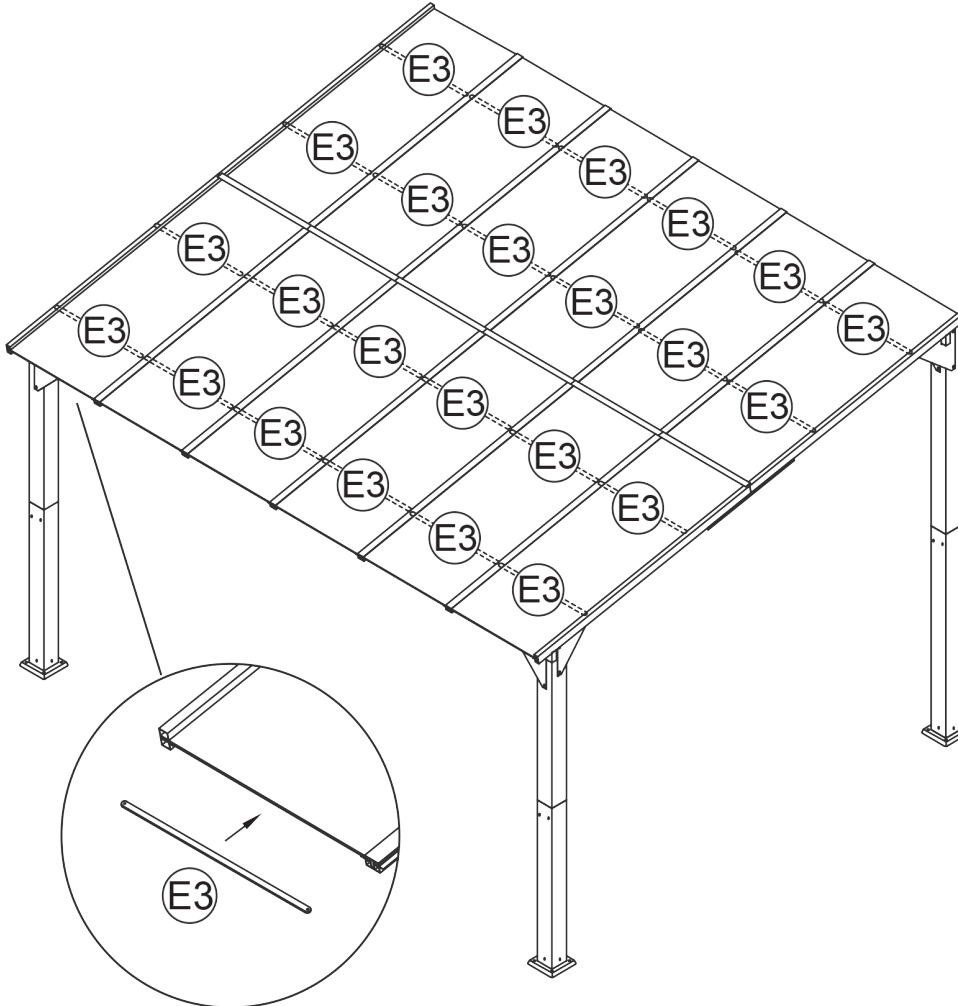

If you have any question please contact customer service:

**E-mail:** [support@pamapic.com](mailto:support@pamapic.com)  
**Facebook:** [@pamapic.official](https://www.facebook.com/pamapic.official)

Instruction Video



# INSTRUCTIONS

## Step 12

F1		X2	F2		X2
J1		X2	J2		X2
J3		X4	P		X14
			W		X2

W is the sink pipe in the very middle. Align the holes of sinks F1, F2, and W, with the side featuring holes facing downward.

Secure the drainage outlets J1 and J2 with screws P, as shown in the diagram.

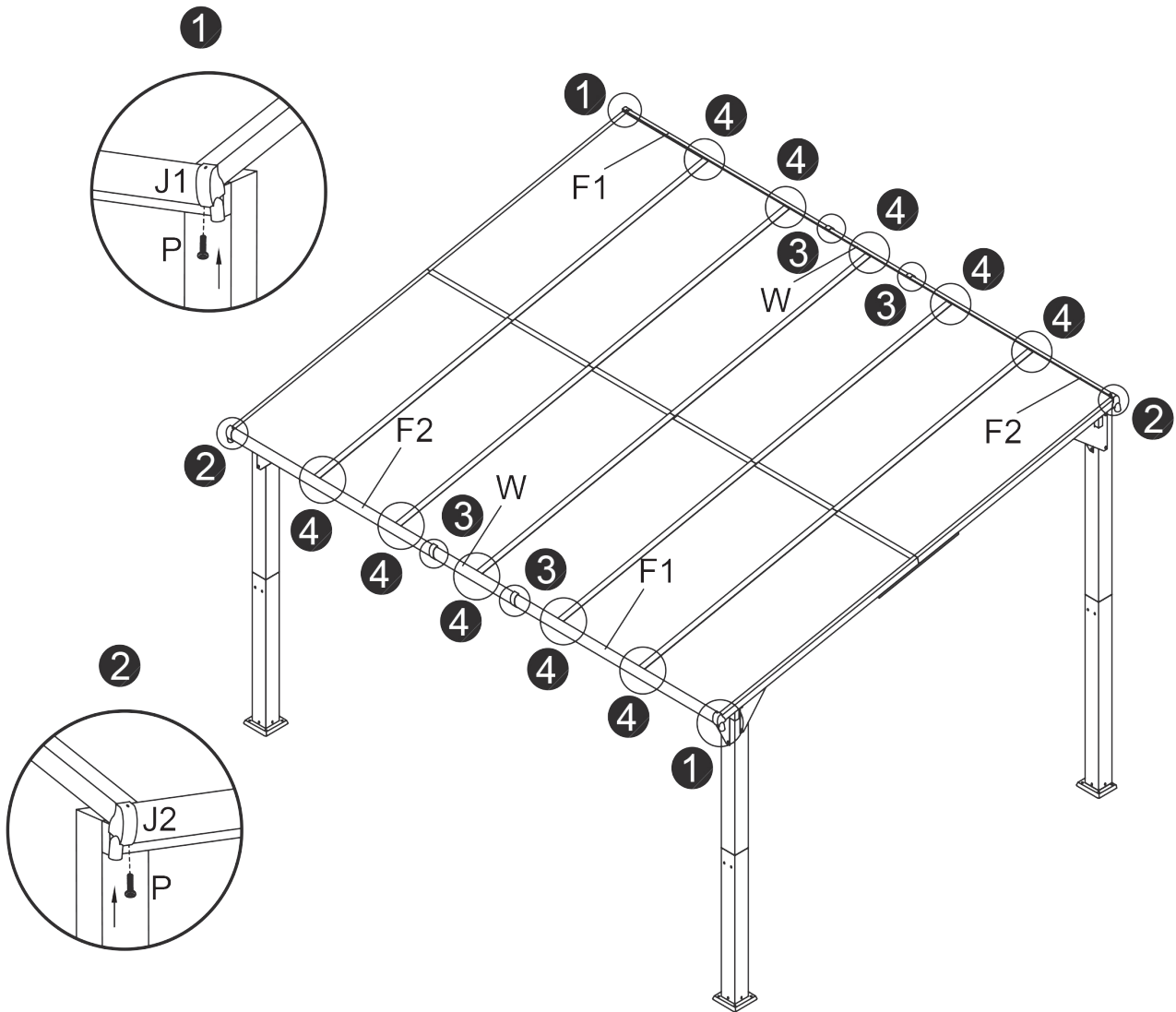

If you have any question please contact customer service:







**E-mail:** [support@pamapic.com](mailto:support@pamapic.com)  
**Facebook:** [@pamapic.official](https://www.facebook.com/pamapic.official)

Instruction Video



# INSTRUCTIONS

## Step 12

F1		X2	F2		X2
J1		X2	J2		X2
J3		X4	P		X14
			W		X2

W is the sink pipe in the very middle. Align the holes of sinks F1, F2, and W, with the side featuring holes facing downward.

Secure the drainage outlets J1 and J2 with screws P, as shown in the diagram.

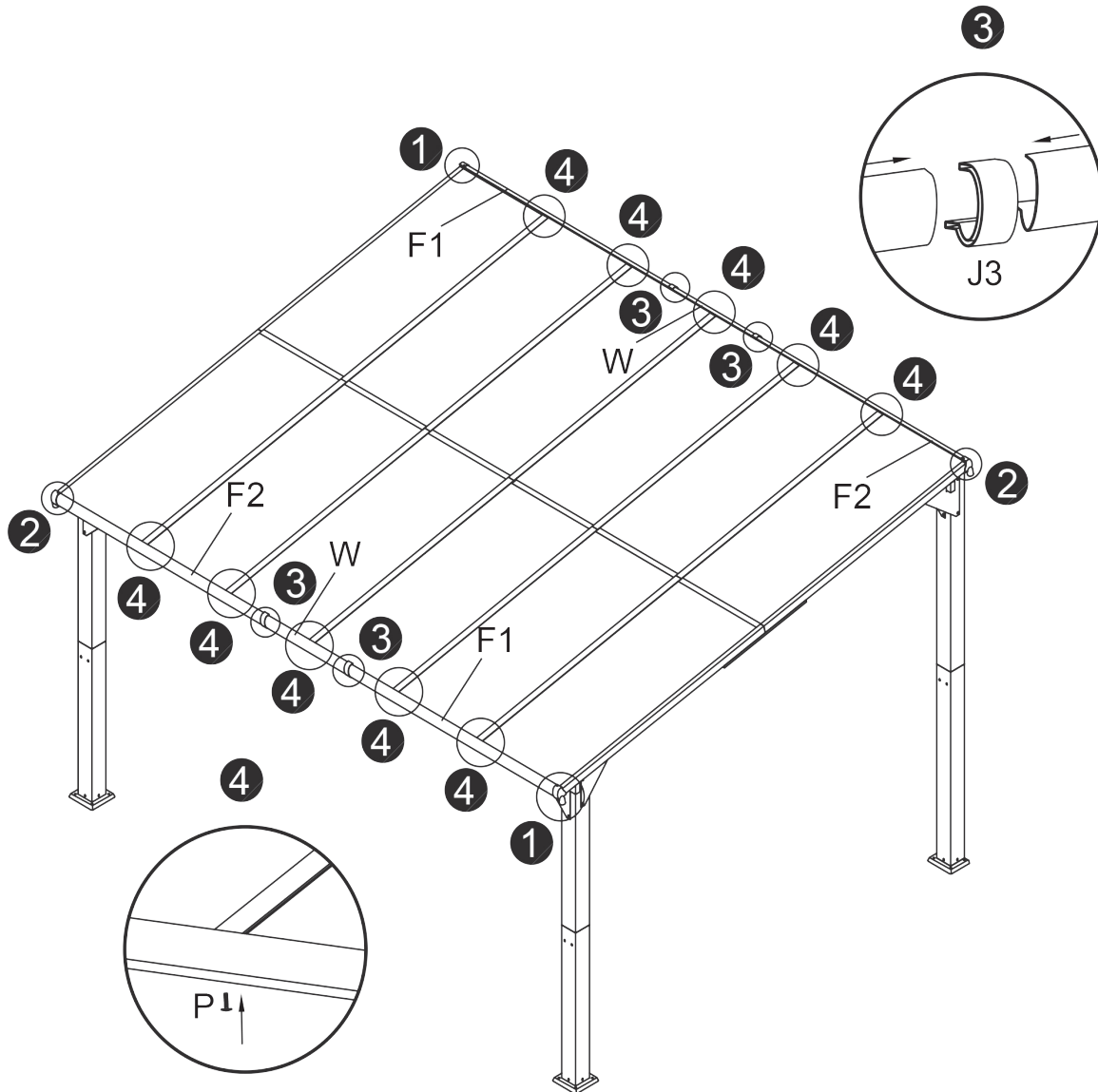

Instruction  
Video



If you have any question please  
contact customer service:

**E-mail:** [support@pamapic.com](mailto:support@pamapic.com)  
**Facebook:** [@pamapic.official](https://www.facebook.com/pamapic.official)

# INSTRUCTIONS

## Step 13

U/U(2)		X16
--------	---	-----

As shown in the diagram, use screws U to fix the base to the ground.  
For safety reasons, please fully tighten screws U.

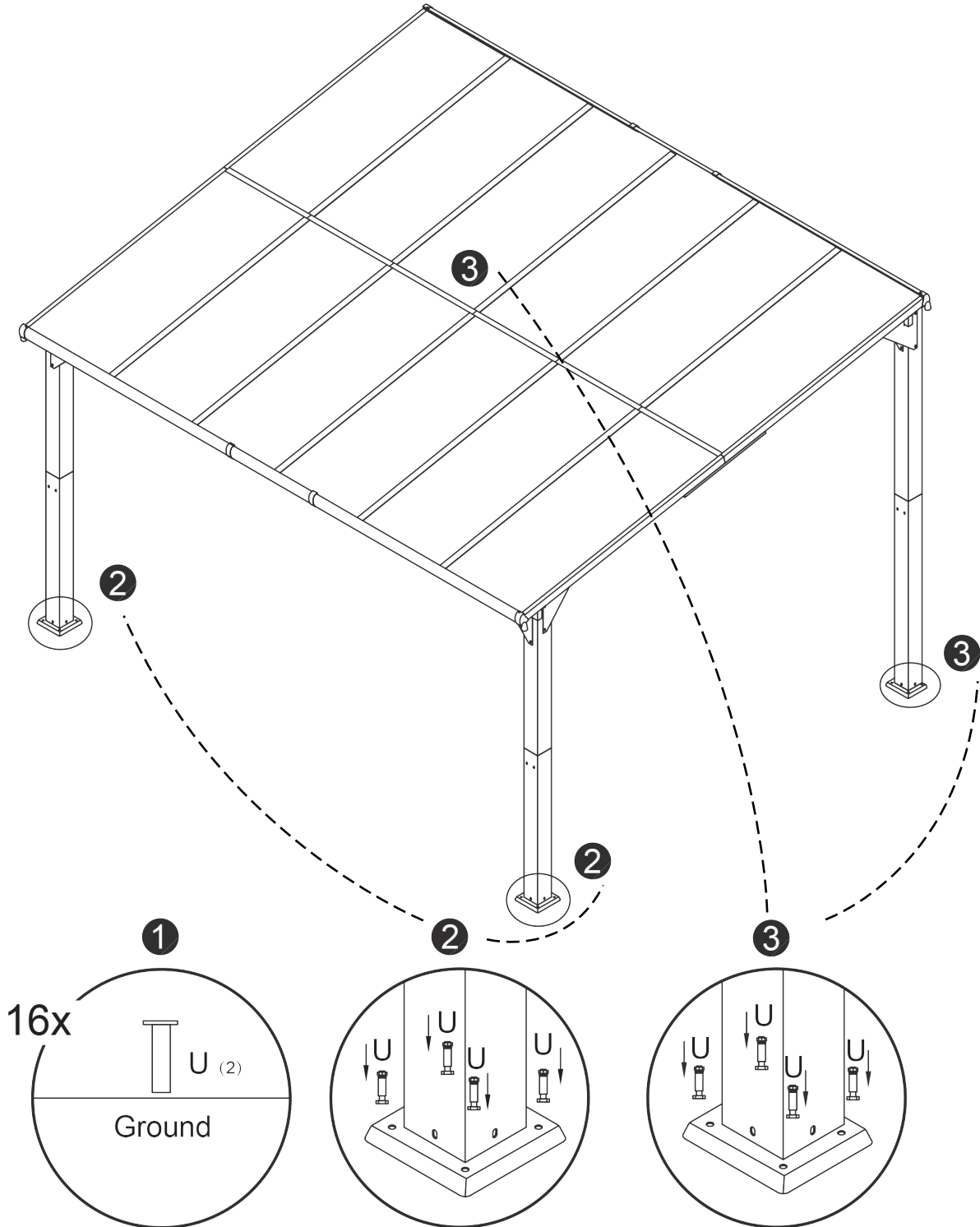

Instruction  
Video







If you have any question please  
contact customer service:

**E-mail:** [support@pamapic.com](mailto:support@pamapic.com)  
**Facebook:** [@pamapic.official](https://www.facebook.com/pamapic.official)

# INSTRUCTIONS

## Step 14

I2		X2	S		X4
U/U(2)		X2	B3		X1

As shown in the diagram, secure I2 to the pillar with screws S, and fasten I2 to the wall with screws U. For safety purposes, please fully tighten screws U.

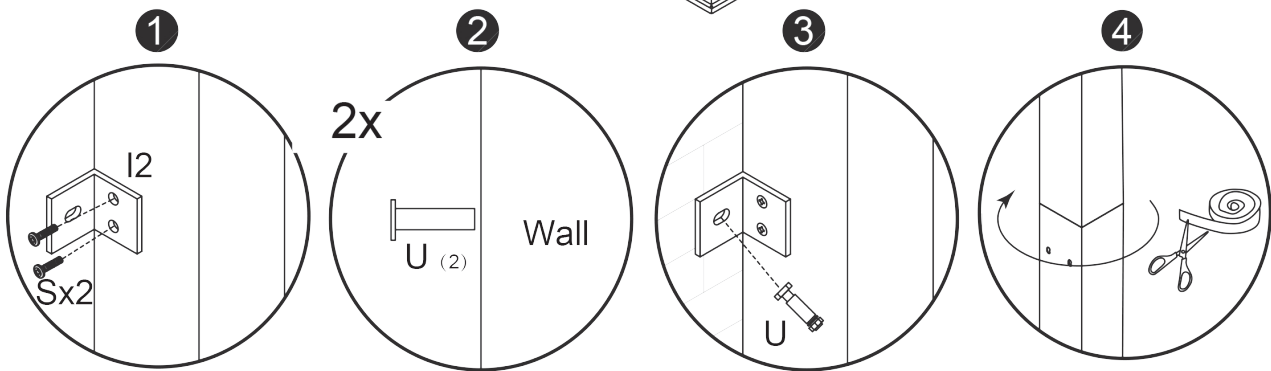
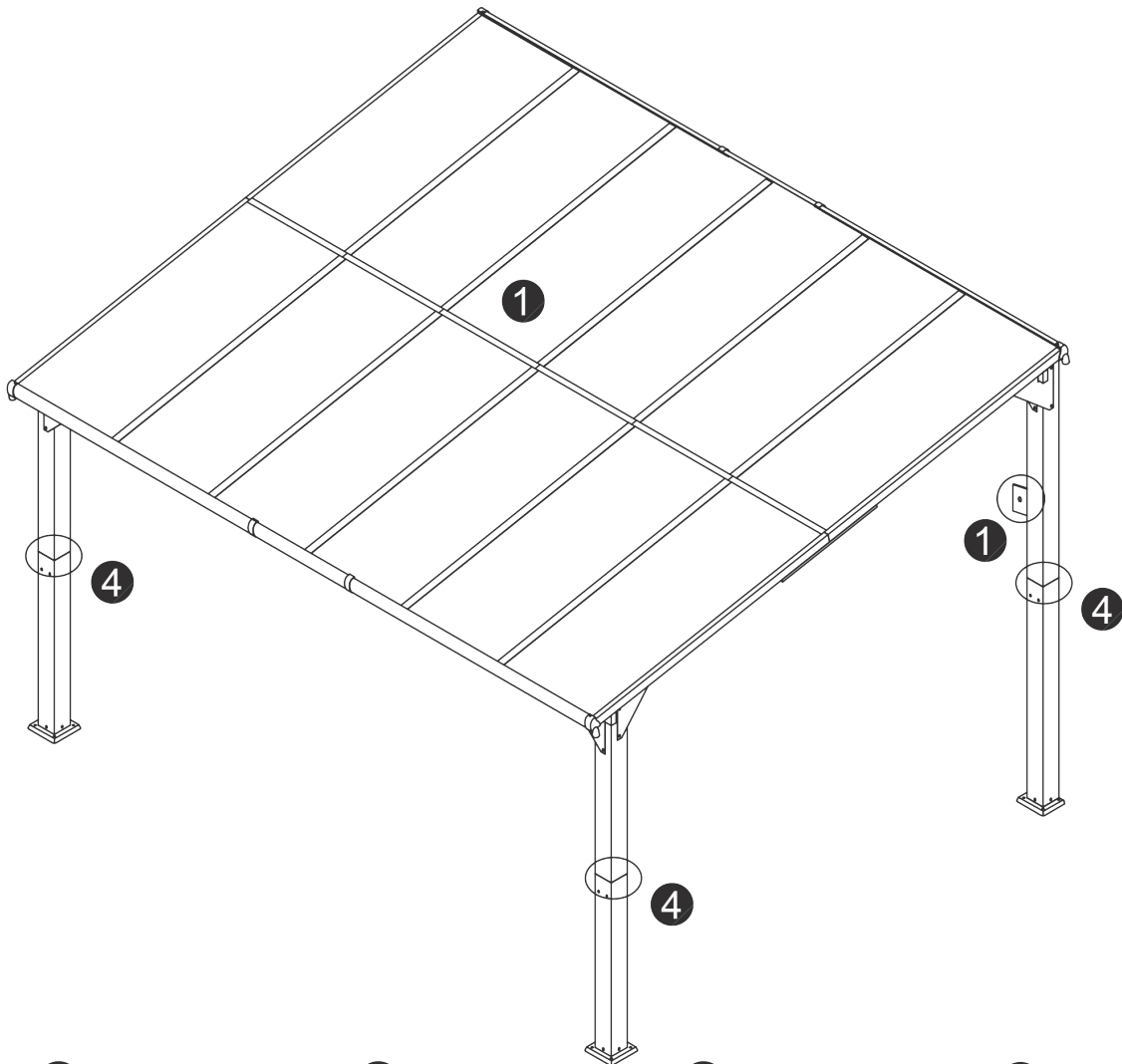

If you have any question please contact customer service:

**E-mail:** [support@pamapic.com](mailto:support@pamapic.com)  
**Facebook:** [@pamapic.official](https://www.facebook.com/pamapic.official)

Instruction Video





---

If you have any question please  
contact customer service:

**E-mail:** [support@pamapic.com](mailto:support@pamapic.com)  
**Facebook:** [@pamapic.official](https://www.facebook.com/pamapic.official)

Instruction  
Video





## Elevate your outdoors Embrace the moments

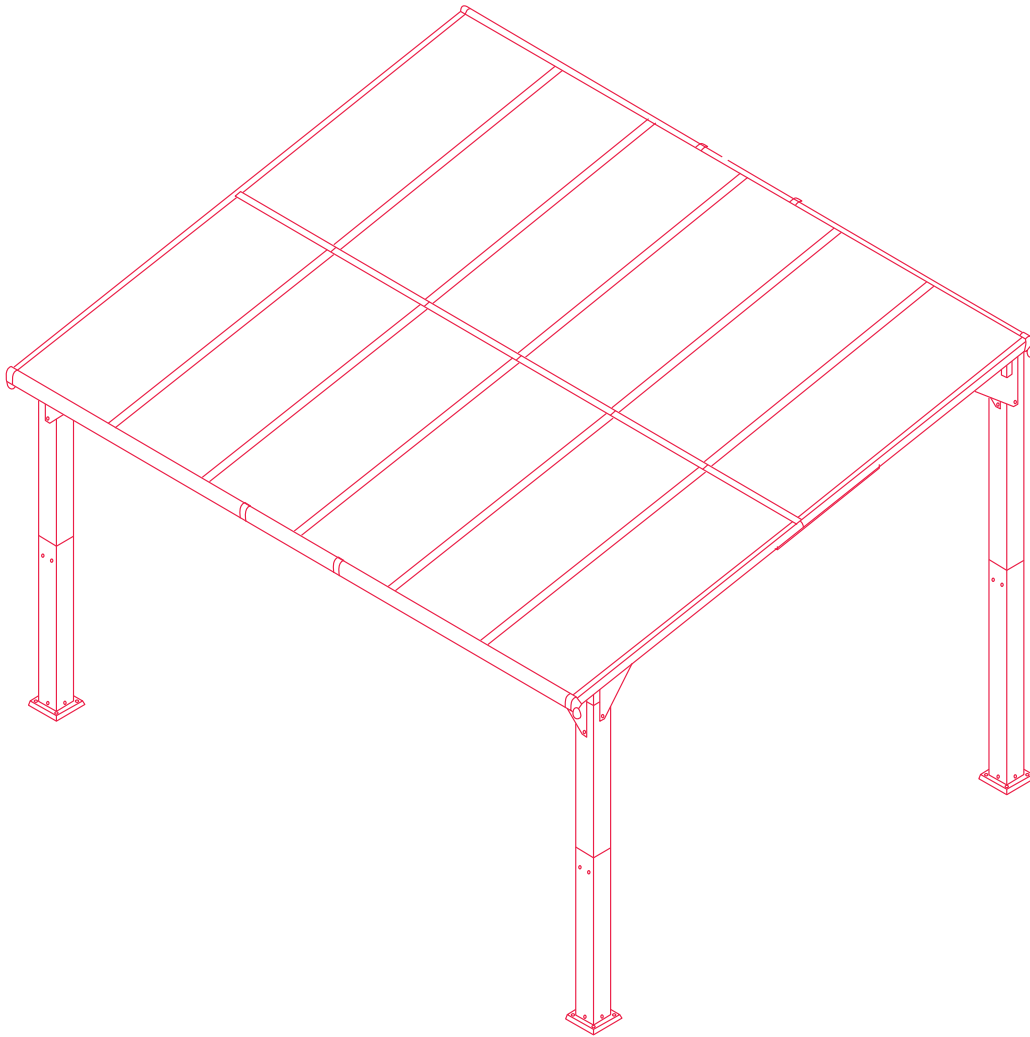

Instruction  
Video



If you have any question please  
contact customer service:

**E-mail:** [support@pamapic.com](mailto:support@pamapic.com)  
**Facebook:** [@pamapic.official](https://www.facebook.com/pamapic.official)